



TRISMAC

Trilateral Safety and Mission Assurance Conference **2024**

24-26 June 2024

ESA-ESRIN | Frascati (RM), Italy

Benefits of using functional safety in commercial space applications

Florian Lumpe DLR-NPQ, Normung, Produktsicherung, Qualifizierung

Michael Seidl, Texas Instruments Deutschland GmbH

BENEFITS OF USING FUNCTIONAL SAFETY IN COMMERCIAL SPACE APPLICATIONS

TRISMAC, 24 – 26 June 2024 | ESA-ESRIN | Frascati (Rome), Italy

Florian Lumpe DLR-NPQ, Normung, Produktsicherung, Qualifizierung

Michael Seidl, Texas Instruments Deutschland GmbH



TEXAS INSTRUMENTS

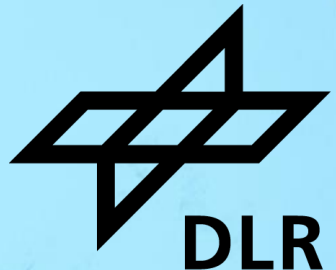

Benefits of using functional safety in commercial space applications



Agenda

- NewSpace forces a new and comprehensive look at system level resiliency
- Commonalities of RAMS and IEC61508 functional safety
- System-on-chip (SoC): functional safety benefits for space

New space forces a new and comprehensive look at system level resiliency



- Growing system level complexity requires methodical validation and verification
 - Minimize faults caused by system architects, hardware and software designers
 - Minimize faults caused by the design tools
- Commercialization drives for a balance between cost, performance, time & risk
 - Acceleration of development cycles (design, manufacturing, test, deployment)
 - Avoidance of costly over-engineering
 - Repeatability to maximize the return of investment
 - Re-use
 - Economies of scale (volume production)
 - Accountability (& measurability) for cost, performance, time & risk
- Higher volumes from new space enable new focus from semiconductor industry on space segment

How space could benefit from other industry segments

E.g. automotive



Innovation attributes

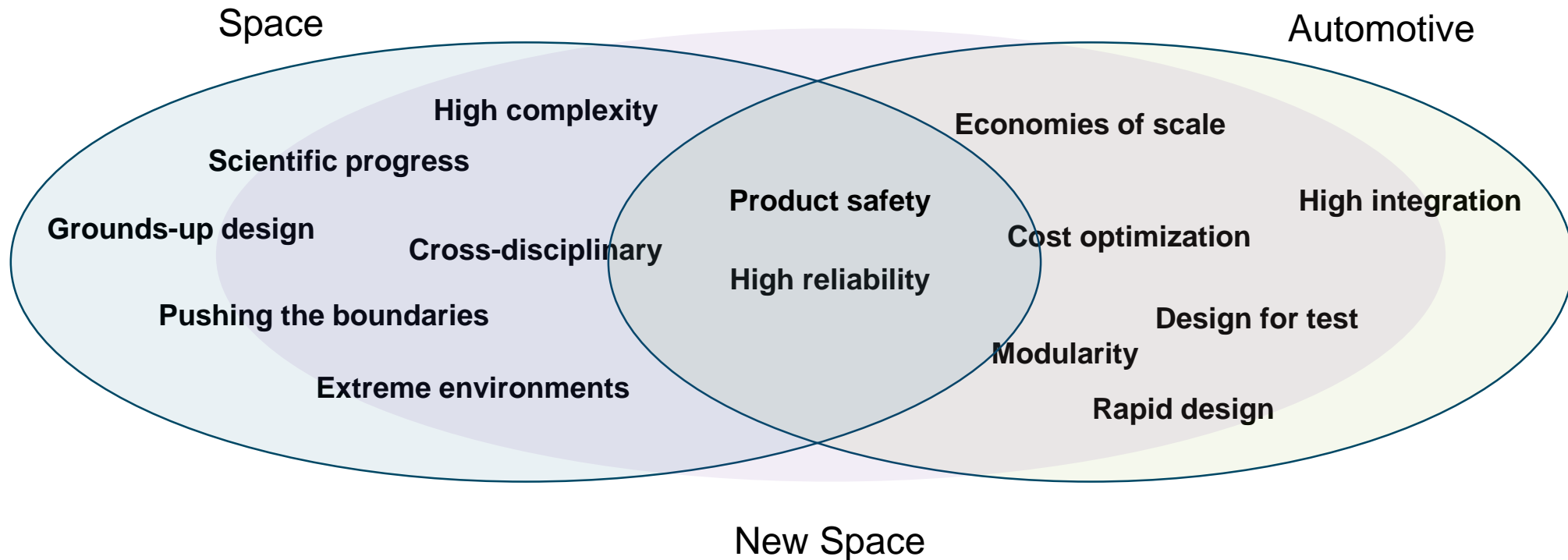

Benefits of adopting functional safety in commercial space applications

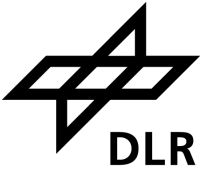

Agenda

- NewSpace forces a new and comprehensive look at system level resiliency
- **Commonalities of RAMS and IEC61508 functional safety**
- System-on-chip (SoC): functional safety benefits for space

Standardization Overview



Based on IEC 61508

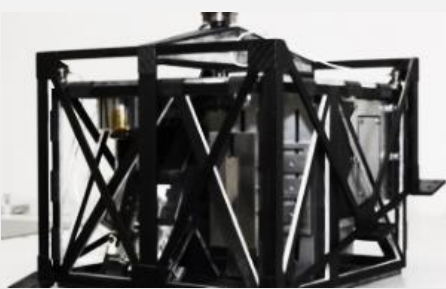

Space ECSS/ NASA

- **RAMS** - reliability, availability, maintainability, safety (dependency)
- **FDIR**- Fault Detection Isolation and Recovery
- Safety level EEE
- Low volume production



Aviation DO-254

- Functional safety
- DAL Design Assurance Level



Process industry IEC 61511

- Functional safety
- (GSE) rocket test pad
- Diagnostic coverage (DC)
- SIL level
- HAZOP/ LOPA



Automotive ISO 26262

- Functional safety
- Autonomous driving
- ASIL
- HARA/ HAZOP
- High volume production



Mechanical-E DIN EN 62061 DIN EN 13849

- SIL
- Category B,1,2,3,4
- Industrial engineering
- Laser systems on Earth

Source: [DLR \(CC BY-NC-ND 3.0\)](#)

Space and IEC61508 share same approach and objective



RAMS

Reliability: Ability to perform a specific function; may be given as design reliability or operational reliability

Availability: Ability to keep a functioning state in the given environment.

Maintainability: Ability to be maintained (servicing, inspection and check, repair and/or modification) in an easy and timely manner.

Safety: Ability to prevent harm to people, the environment and assets during a complete life cycle.



IEC61508 functional safety

Functional safety standards for the lifecycle of electrical, electronic, or programmable electronic (E/E/PE) systems and products.

Also includes RAMS approaches

Functional safety refers to safety functions, but can also be applied to basic functions

Specified process, includes specific tools and methods



Assure freedom from unacceptable risk

Risk

=

**Severity
of the damage**

x

**Probability
of occurrence of this damage**

Systematic and random failure in functional safety

Random failures

HW: e.g. resistor shortcut, transistor gate rupture

- ... are basically unavoidable
- ... can not be eliminated after being detected
- ... must be controlled to mitigate their impact
- ... can be statistically modeled with reasonable accuracy
- ... λ -rate, FIT, PFH, PFD, MTTF, etc.

Quantitative approach

Measures: self-diagnostic, redundancy, ...

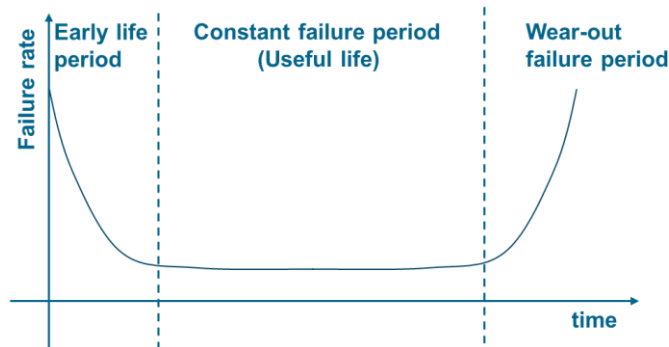

E.g. random failure rate for a simple device

Systematic failures

HW or SW: e.g. specification faults, software bugs

- ... are basically avoidable
- ... are in essence due to mistakes
- ... can be eliminated after being detected
- ... cannot be statistically modeled
- ... concept of **Systematic Capability**
(IEC61508: scale of SC 1 to SC 4 → SIL 1-4)

Qualitative approach

Measures: managed process, installed base analysis

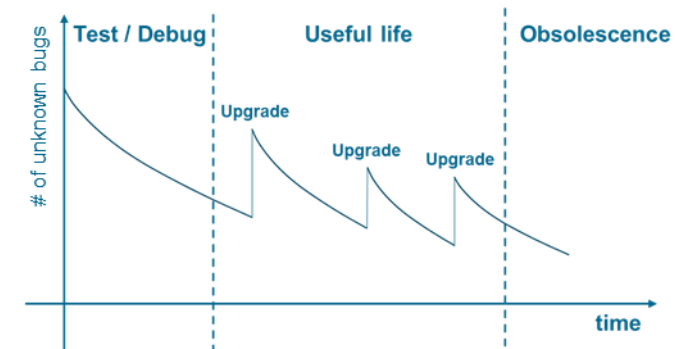

E.g. Quality life-cycle of a software product

Benefits of adopting functional safety in commercial space applications



Agenda

- NewSpace forces a new and comprehensive look at system level resiliency
- Commonalities of RAMS and IEC61508 functional safety
- System-on-chip (SoC): functional safety benefits for space

Growing system level complexity requires strong collaboration with semiconductor industry



OEM high reliability / functional safety concept

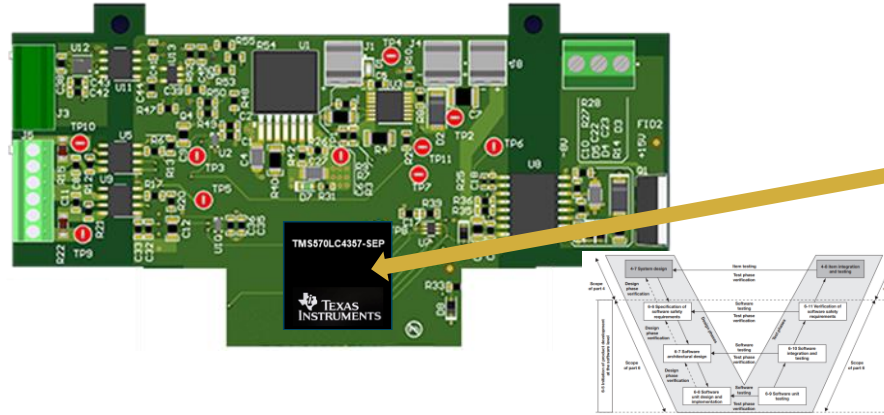
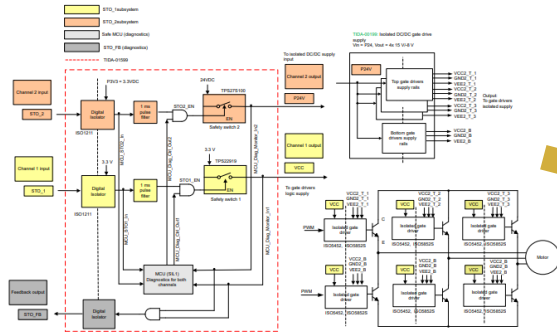

Functional safety capable System-on-Chip

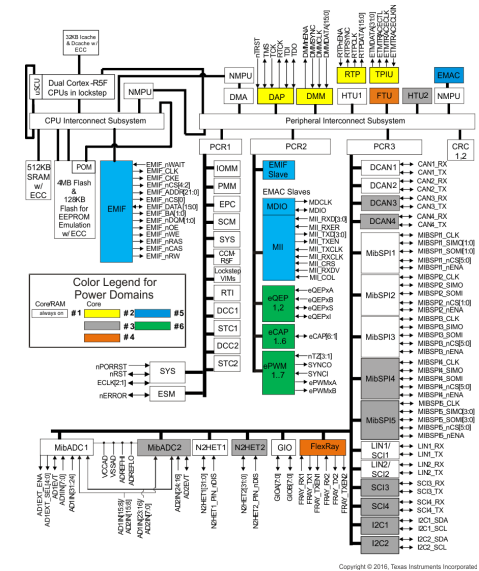

- System-on-Chip
 - Must provide sufficient safety capability to minimize risk mitigation efforts at system level
 - Pre-defines the limit of reachable reliability level of the system
- Level of integration keeps growing:
 - 100's of millions+ of transistors enabling 1000's of GOPS+ (trillion operations per second)
 - Greater importance in avoiding systematic failure
- High volumes of automotive are a strong driver for 'integration of safety' (Self-test, error correction, clock monitor, ...)

Microelectronic functional safety support

Three chain links of risk mitigation to accomplish “freedom from unacceptable risk”

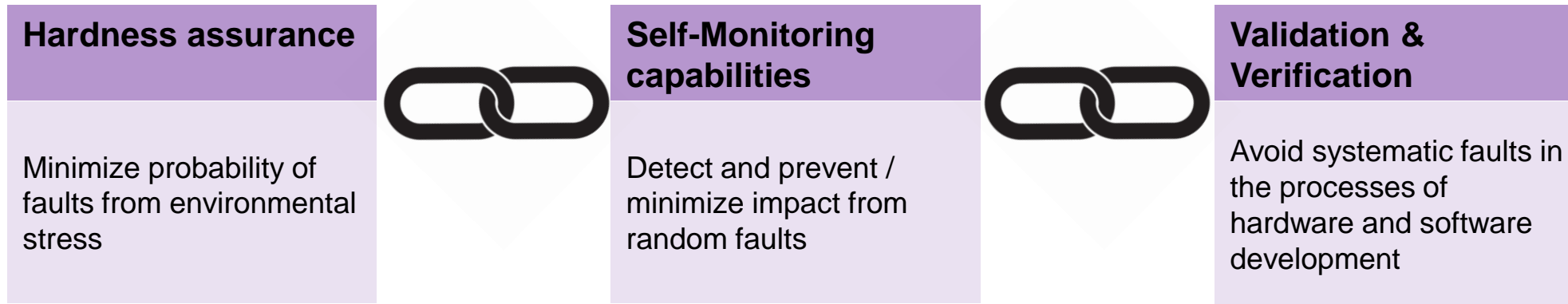

Using a component in the wrong environment is a systematic fault

Qualification with 100% functional test coverage towards expected:

- Radiation levels (TID & SEE)
- Temp cycles (soldering & in-orbit)
- Air pressure
- Operation life cycle
- Vibration

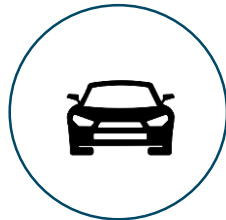
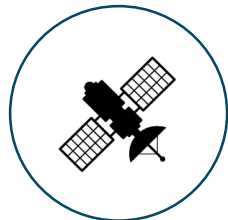

Integrated features and IP-blocks

- Diagnostic coverage e.g. loopback mode, built-in self tests (BIST)
- Fast fault detection to minimize Fault Tolerant Time Interval, e.g. CRC, lockstep
- Self-healing capabilities, e.g. ECC

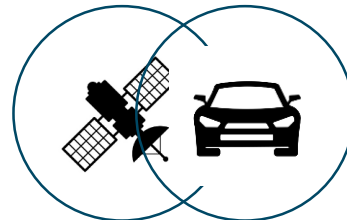

Standardized functional safety development process

- Training and organization of development team
- Qualification of hardware and software development tools
- Clearly defined check points for validation and verification (V- process)
- Documentation and QM

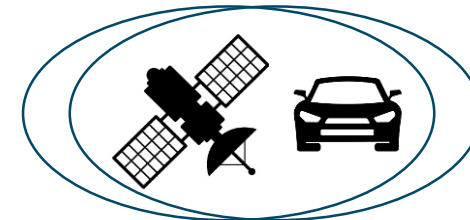

Functional safety MCU TMS570LC4357-SEP

Applied risk mitigation to accomplish “freedom from unacceptable risk”



Truly space-qualified by the vendor:

- Radiation: 30 krad / 43 MeV-cm2/mg
- Temp Range : -55°C to +125°C
- Robust Material Set
- Enhanced Qualification, e.g. HAST
- ...

Integrated hardware diagnostics:

- Dual-core lockstep CPUs
- ECC on Flash and RAM interfaces
- Built-In Self-Test (BIST)
- Voltage and clock monitoring
- ...

Grounds-up functional safety design:

- ISO 26262 with ASIL-D capability
- IEC 61508 with SIL-3 capability
- Software & Hardware development process certified by TÜV
- ...

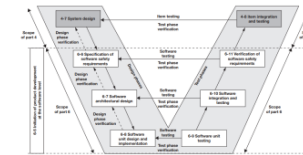
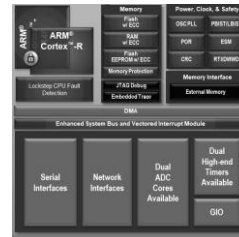
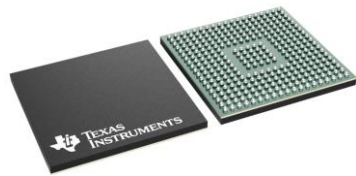

Hardness assurance

Minimize probability of faults from environmental stress



Self-monitoring capabilities

Detect and prevent / minimize impact from random faults



Validation and verification

Avoid systematic faults in the processes of hardware and software development

Functional safety MCU on Mars

Two TMS570 Hercules MCUs form highly resilient flight controller



Lock-step MCU enables near-instant fault detection

- FPGA switches to redundant MCU

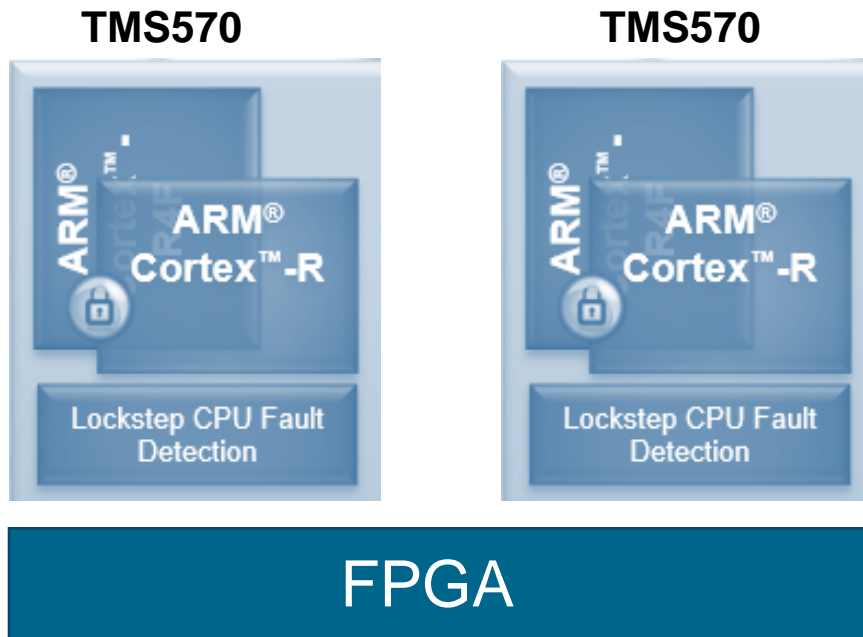
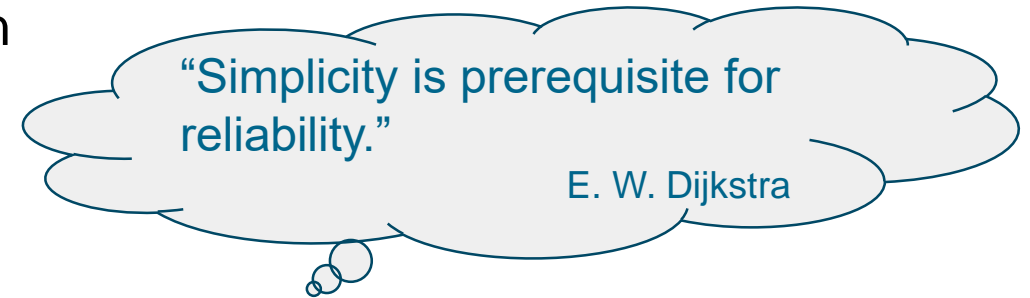

The future in Space needs new strategic thinking



New approach for faster development cycles, more cost effectiveness, increased capabilities, yet highly reliable:

- EEE cross pollination from other industries, e.g. the automotive industry has strong experience in
 - High competition
 - Mass production
 - No failure strategy (recalls are fatal)
 - Functional safety
- Adopt functional safety (IEC61508) thinking to enable its use in space projects

Today's speakers Michael Seidl Texas Instruments

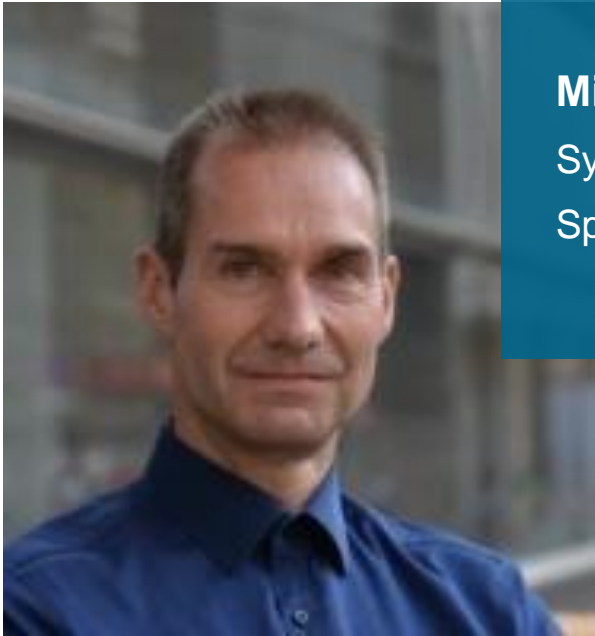

Michael Seidl
Systems Engineer,
Space and Avionics

Michael Seidl
m-seidl@ti.com / +49 163 80 62 575

Texas Instruments Deutschland GmbH
Haggertystr. 1
85356 Freising
www.ti.com/space

Michael received his Dipl. Ing. (FH) degree in communication technologies from Fachhochschule Munich in Germany.

Michael has 28 years of experience in semiconductors and held positions in DSP software design, applications, product marketing, business development and system engineering.

Michael is a Systems Engineer for Aerospace Applications at Texas Instruments. He supports customers in their decision making with in-depth system knowledge, combined with expertise on TI's product offerings.

Today's speakers Florian Lumpe DLR R&D



Florian Lumpe, DLR
Coordinator Strategic
Product Assurance

Florian Lumpe began his career in the aerospace industry a academic degree in mechanical engineering and general management. In his current role as Coordinator Strategic Product Assurance at the German Aerospace Centre in Cologne, he coordinates the integration of Product assurance into projects.

Florian is Coordinator Strategic Product Assurance for R&D at the DLR. His tasks include the management of technical interfaces and the adaptation of legal requirements, as well as the design and implementation of training courses. As an auditor, he contributes to optimizing the company's performance.

Deutsches Zentrum für Luft- und Raumfahrt (DLR)

Qualitäts- und Produktsicherung | Normung, Produktsicherung & Qualifizierung | Linder Höhe | 51147 Köln

Dipl.-Ing. **Florian Lumpe** M.Sc. | Koordinator Strategische Produktsicherung

Telefon +49 2203 601-3694 | Telefax +49 2203 601-3235 | florian.lumpe@dlr.de

[Funktionale Sicherheit in der Luft- und Raumfahrt \(dke.de\)](https://www.dlr.de/funktionale-sicherheit-in-der-luft-und-raumfahrt-dke.de)