

Thursday, 15. February 2024

Session XX: Mobility

15 – 16 FEBRUARY 2024

**VAN DER VALK
AIRPORTHOTEL
DÜSSELDORF –
GERMANY**



**SUCCESSFUL R&I
IN EUROPE 2024
11th EUROPEAN
NETWORKING EVENT**

Towards large-scale Deployment of European Sustainable Aviation Fuels (SAF)

**Asif Ansar, Ralph-Uwe Dietrich, Simon Maier, Julia Weyand
(DLR e.V., www.DLR.de/tt)**



Electrolysers Development & Integration Capabilities @ DLR

15-16 FEBRUARY 2024
VAN DER VALK
AIRPORTHOTEL
DÜSSELDORF -
GERMANY



SUCCESSFUL R&I
IN EUROPE 2024
11th EUROPEAN
NETWORKING EVENT



- Process engineering for electrolyser ins multi-MW range applications, including upstream and downstream integration
- Stack and module testing up to 150 kW & 100 bars. Linking large-scale experiments with process system modelling
- Transient models & control systems for optimizing dynamic operations
- Demonstrators build-up and testing

Experimental reactor investigations

Transient process system simulations

Process system experiments

Process system concepting

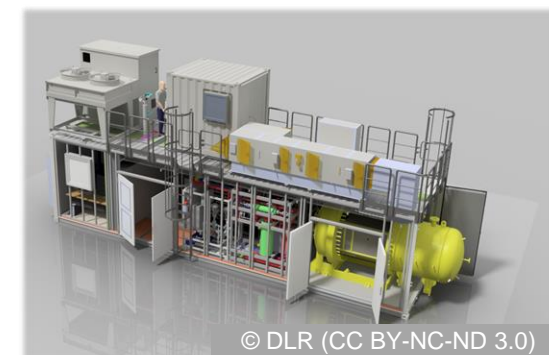
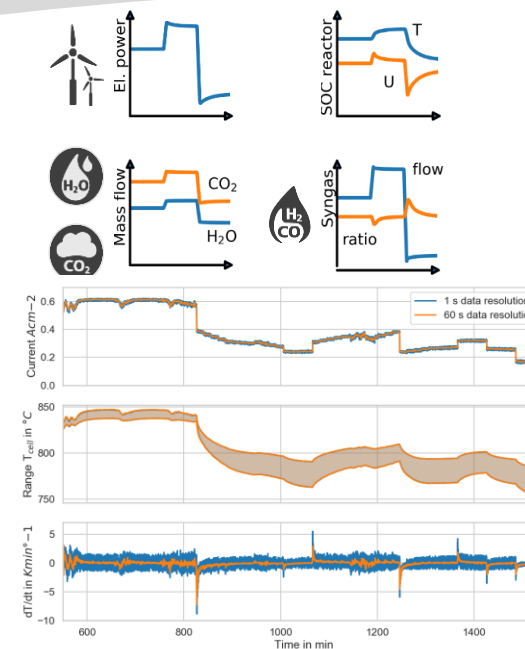
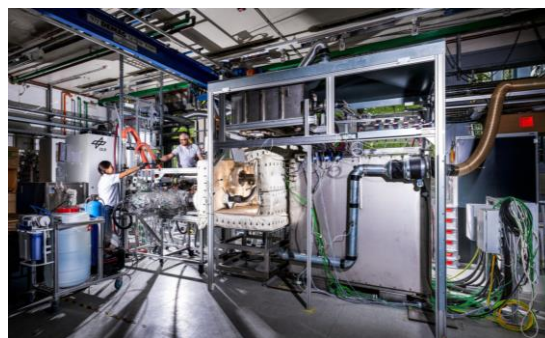
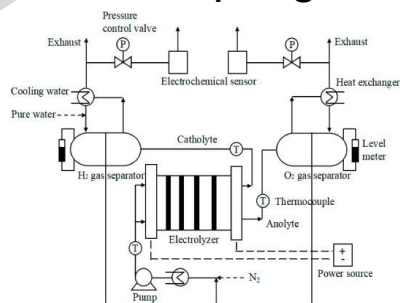

© DLR (CC BY-NC-ND 3.0)

Techno-Economic and Life Cycle Assessment @ DLR

15-16 FEBRUARY 2024
VAN DER VALK
AIRPORTHOTEL
DÜSSELDORF -
GERMANY



SUCCESSFUL R&I
IN EUROPE 2024
11th EUROPEAN
NETWORKING EVENT

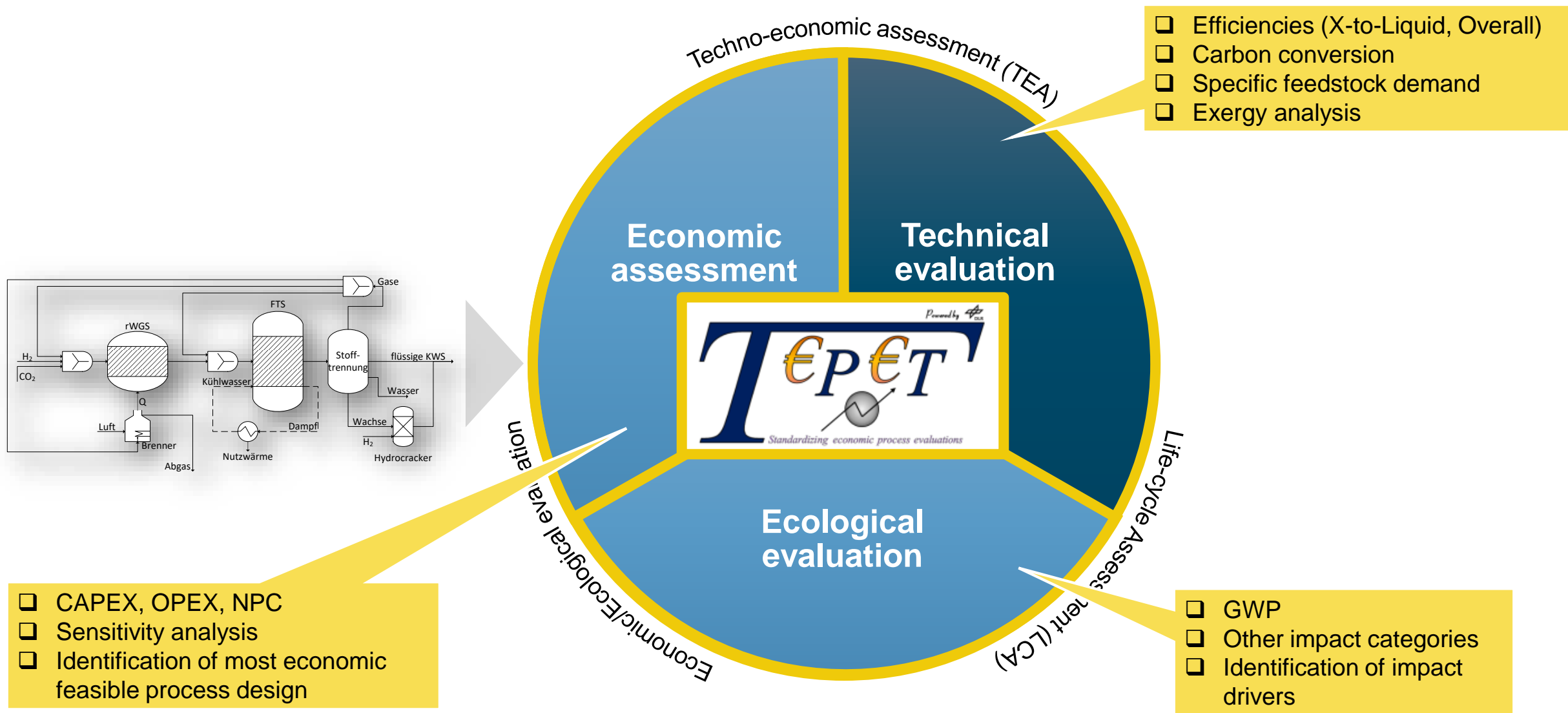
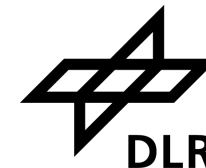

Process Idea



FLEXCHX project has received funding from the European Union's Horizon 2020 research and innovation programme under grant agreement No 763919



15-16 FEBRUARY 2024
VAN DER VALK AIRPORTHOTEL
DÜSSELDORF - GERMANY



SUCCESSFUL R&I IN EUROPE 2024
11th EUROPEAN NETWORKING EVENT

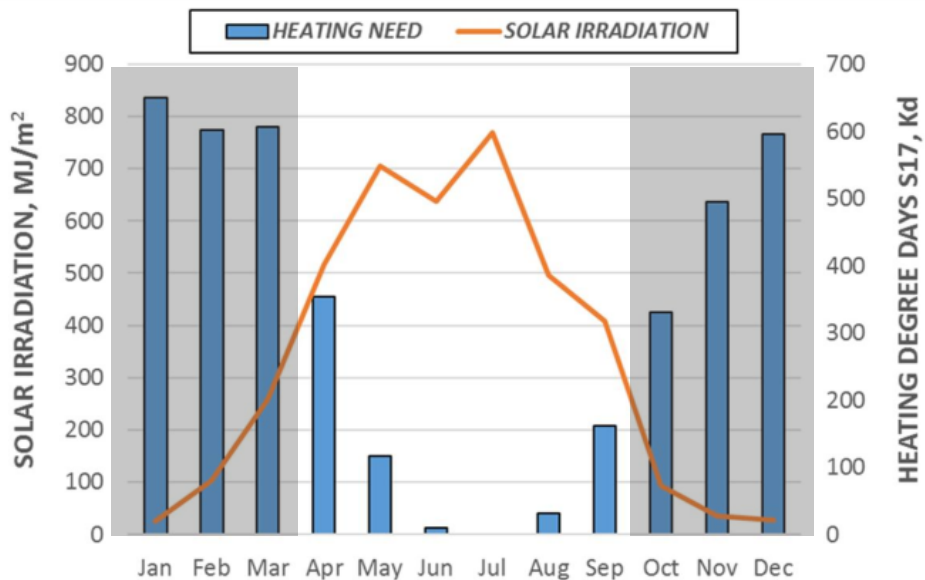

High heat demand & Low renewable electricity availability

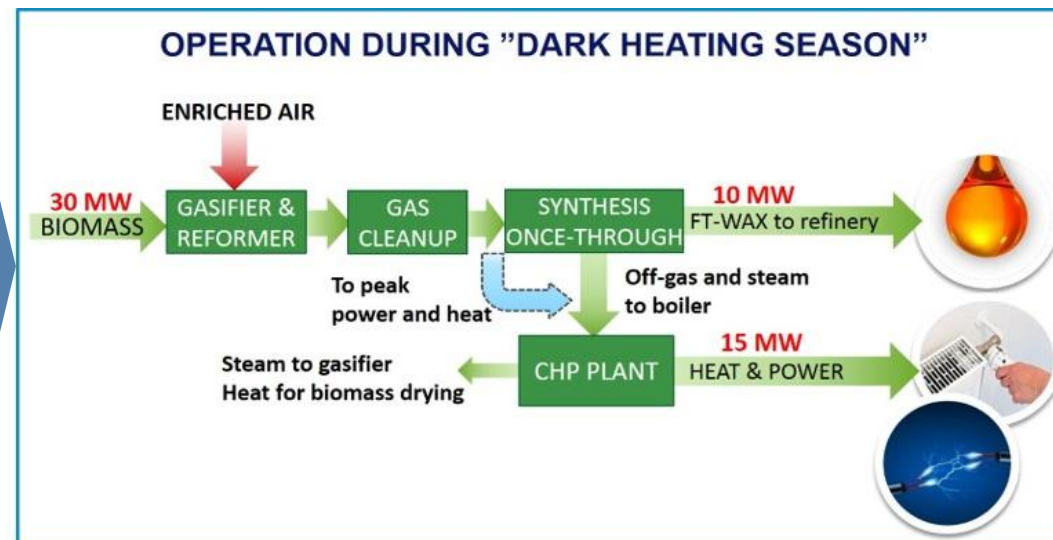

Process Idea



FLEXCHX project has received funding from the European Union's Horizon 2020 research and innovation programme under grant agreement No 763919



15-16 FEBRUARY 2024
VAN DER VALK AIRPORTHOTEL
DÜSSELDORF - GERMANY



SUCCESSFUL R&I IN EUROPE 2024
11th EUROPEAN NETWORKING EVENT

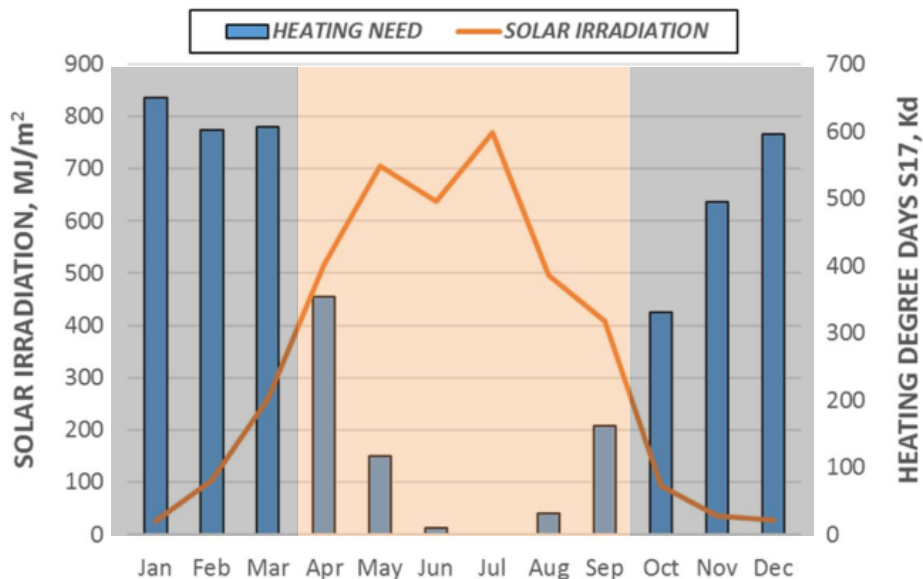

High heat demand & Low renewable electricity availability

Low heat demand & High renewable electricity availability

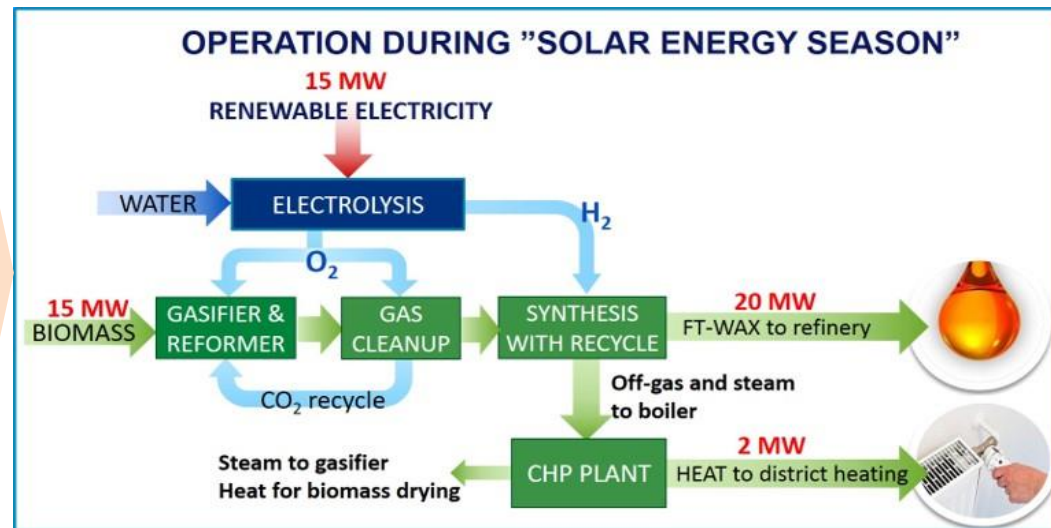
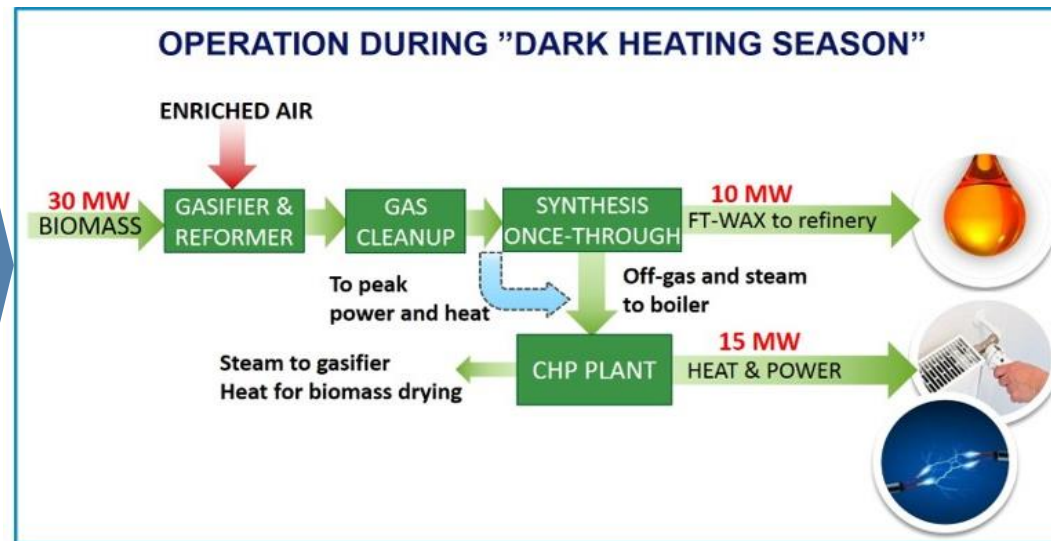

Cost Breakdown of Power&Biomass-to-Liquid

15-16 FEBRUARY 2024
VAN DER VALK
AIRPORTHOTEL
DÜSSELDORF -
GERMANY



SUCCESSFUL R&I
IN EUROPE 2024
11th EUROPEAN
NETWORKING EVENT

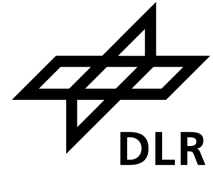

Base case NPC: 1.08 €₂₀₁₉/l_{C5+}

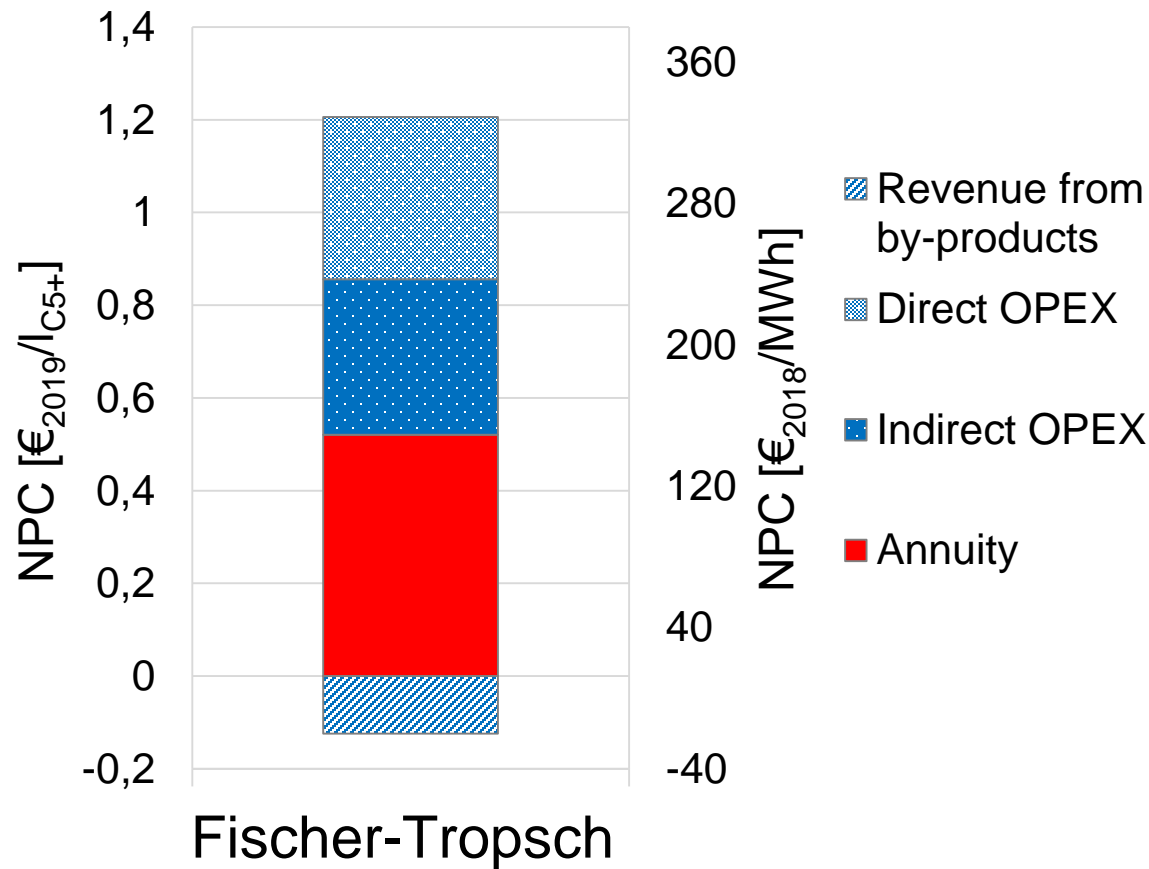

Cost Breakdown of Power&Biomass-to-Liquid

15-16 FEBRUARY 2024
VAN DER VALK
AIRPORTHOTEL
DÜSSELDORF -
GERMANY



SUCCESSFUL R&I
IN EUROPE 2024
11th EUROPEAN
NETWORKING EVENT

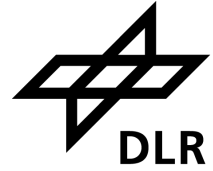

Base case NPC: 1.08 €₂₀₁₉/l_{C5+}

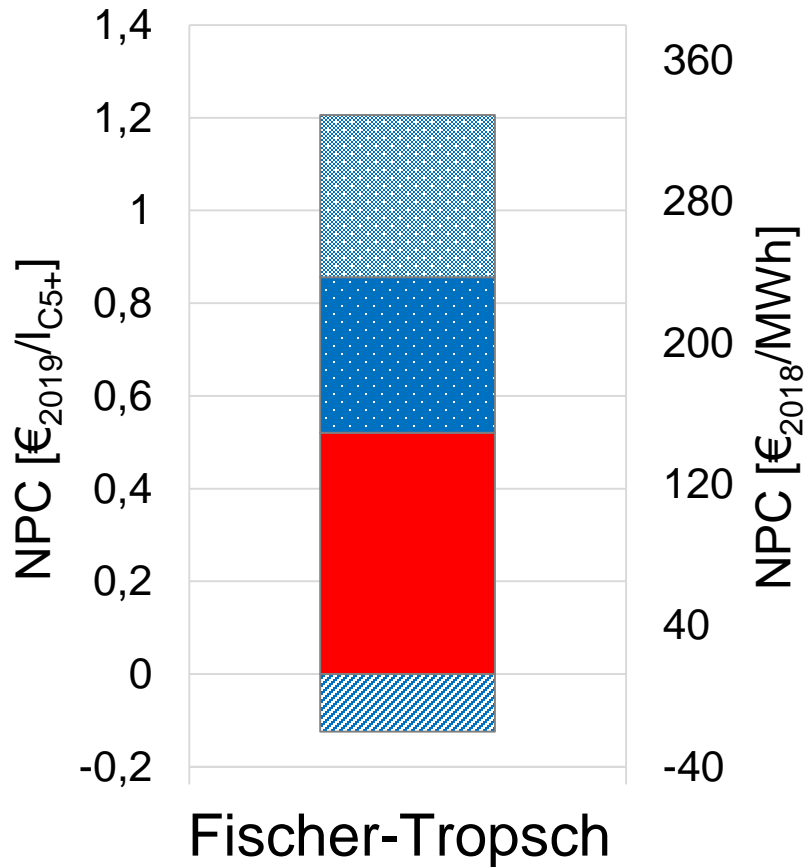

FCI (132 kt/a SAF): 535 M€₂₀₁₈

- ▨ Revenue from by-products
- ▨ Direct OPEX
- ▨ Indirect OPEX
- ▨ Annuity

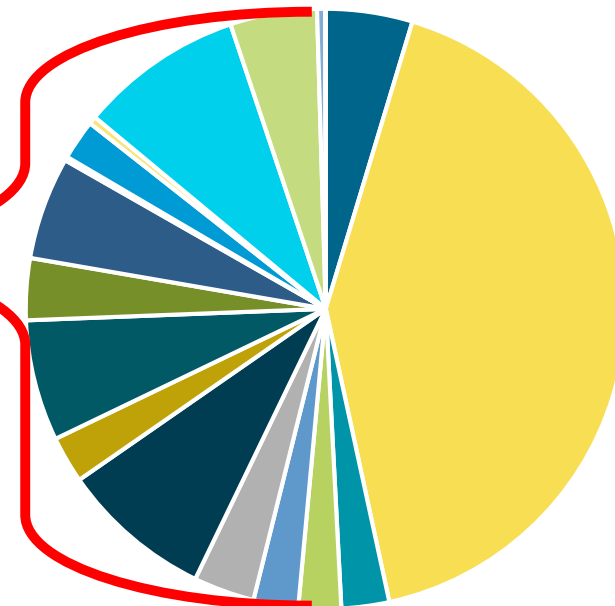

- Biomass handling and Dryer
- AEL
- Ceramic hot-gas-filter
- Guard bed
- Water scrubber
- Selexol CO2 removal
- CFB Gasifier
- HRSG
- ASU
- Civil works
- CHP
- Compressor CO2
- Syngas Compressor
- Oxygen compressor
- FT SBCR
- Catalytic Reformer
- WGS Reactor

European SAF Roadmap

Lowest NPC? → electricity price

15-16 FEBRUARY 2024
VAN DER VALK
AIRPORTHOTEL
DÜSSELDORF -
GERMANY



SUCCESSFUL R&I
IN EUROPE 2024
11th EUROPEAN
NETWORKING EVENT



■ Net Production Costs of PBtL SAF / €₂₀₂₀/kg

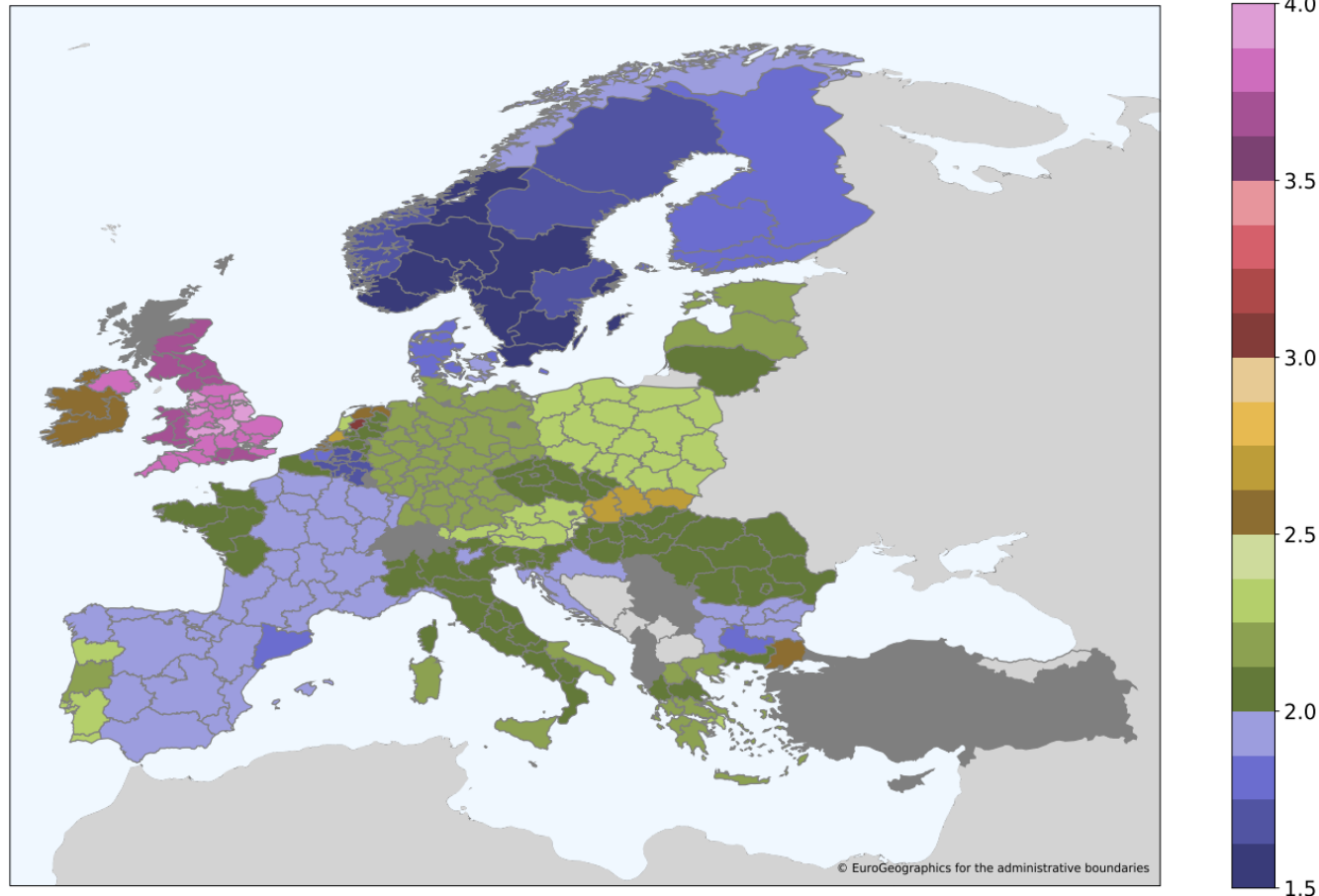

Standard PBtL plant

- 900 MW_e Electrolyzer
- 400 MW_{th} CFB gasifier
- 400 kt/a SAF output

[1] Eurostat, Electricity prices for non-household consumers - bi-annual data. 2021.

[2] Ruiz, P., Nijs, W., Tarvydas, D., Sgobbi, A., Zucker, A., Pilli, R., ... & Thrän, D. (2019). ENSPRESSO-an open, EU-28 wide, transparent and coherent database of wind, solar and biomass energy potentials. *Energy Strategy Reviews*, 26, 100379

European SAF Roadmap

Lowest NPC? → electricity price

15-16 FEBRUARY 2024
VAN DER VALK
AIRPORTHOTEL
DÜSSELDORF -
GERMANY



SUCCESSFUL R&I
IN EUROPE 2024
11th EUROPEAN
NETWORKING EVENT

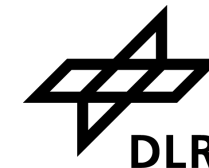

■ Net Production Costs of PBtL SAF / €₂₀₂₀/kg

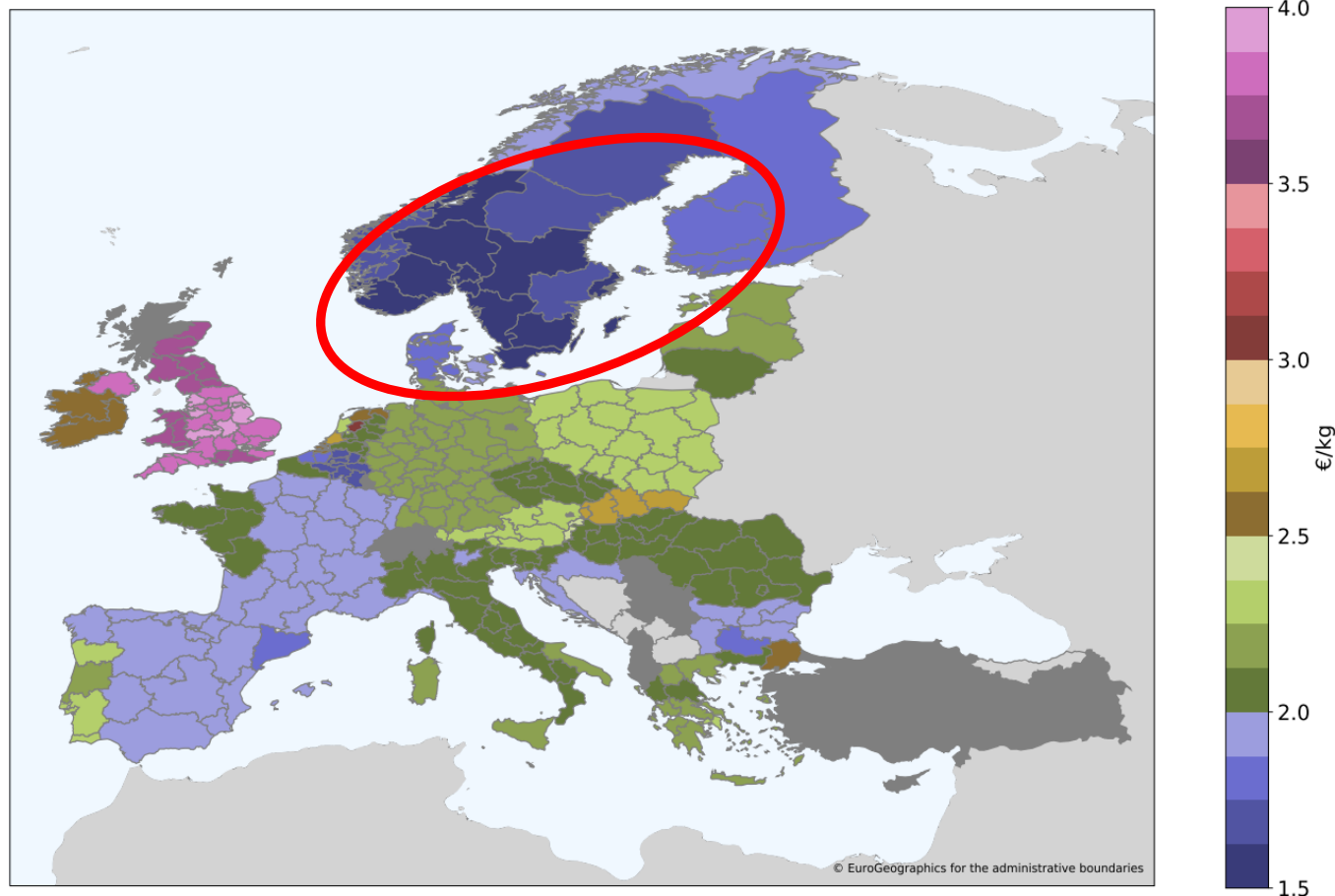

Standard PBtL plant

- 900 MW_e Electrolyzer
- 400 MW_{th} CFB gasifier
- 400 kt/a SAF output

➔ Search for cheap biomass residue and inexpensive (renewable) power [1,2]

1. Norway (57 PJ_{dry biom}/a)
@ 50.5 – 51.0 €₂₀₂₀/t_{biom.dry}
@ 30.8 €₂₀₂₀/kWh grid power
2. Sweden (276 PJ_{dry biom}/a)
@ 57.5 – 64.8 €₂₀₂₀/t_{biom.dry}
@ 35.6 €₂₀₂₀/kWh grid power
3. Finland (201 PJ_{dry biom}/a)
@ 61.5 – 61.9 €₂₀₂₀/t_{biom.dry}
@ 45.9 €₂₀₂₀/kWh grid power

[1] Eurostat, Electricity prices for non-household consumers - bi-annual data. 2021.

[2] Ruiz, P., Nijs, W., Tarvydas, D., Sgobbi, A., Zucker, A., Pilli, R., ... & Thrän, D. (2019). ENSPRESSO-an open, EU-28 wide, transparent and coherent database of wind, solar and biomass energy potentials. *Energy Strategy Reviews*, 26, 100379

Topics to explore

15 – 16 FEBRUARY 2024
VAN DER VALK
AIRPORTHOTEL
DÜSSELDORF –
GERMANY



SUCCESSFUL R&I
IN EUROPE 2024
11th EUROPEAN
NETWORKING EVENT



Future EU projects?

- Renewables / electrolyzer system integration
 - Downstream: fuels, chemicals production (PtX) → efficiency, cost reduction, LCA
 - Upstream: grid support, remote operation → fluctuating operation, system dynamics

Topics to explore

15 – 16 FEBRUARY 2024
VAN DER VALK
AIRPORTHOTEL
DÜSSELDORF –
GERMANY



SUCCESSFUL R&I
IN EUROPE 2024
11th EUROPEAN
NETWORKING EVENT



Future EU projects?

- Renewables / electrolyzer system integration
 - Downstream: fuels, chemicals production (PtX) → efficiency, cost reduction, LCA
 - Upstream: grid support, remote operation → fluctuating operation, system dynamics
- Aviation: new / advanced SAF production
 - New feedstocks
 - New processes
 - New SAF types

Topics to explore

15 – 16 FEBRUARY 2024
VAN DER VALK
AIRPORTHOTEL
DÜSSELDORF –
GERMANY



SUCCESSFUL R&I
IN EUROPE 2024
11th EUROPEAN
NETWORKING EVENT



Future EU projects?

- Renewables / electrolyzer system integration
 - Downstream: fuels, chemicals production (PtX) → efficiency, cost reduction, LCA
 - Upstream: grid support, remote operation → fluctuating operation, system dynamics
- Aviation: new / advanced SAF production
 - New feedstocks
 - New processes
 - New SAF types
- Beyond aviation: new / advanced fuels, chemicals production
 - Marine fuels
 - Heavy load fuels
 - Base chemicals like ammonia, methanol, ...

Partner search

15 – 16 FEBRUARY 2024
VAN DER VALK
AIRPORTHOTEL
DÜSSELDORF –
GERMANY



SUCCESSFUL R&I
IN EUROPE 2024
11th EUROPEAN
NETWORKING EVENT



Are you research oriented ...

- Fuel consumer on the way to sustainable transport?
 - Explore new fuels and its impact on your environmental footprint and costs

Partner search

15 – 16 FEBRUARY 2024
VAN DER VALK
AIRPORTHOTEL
DÜSSELDORF –
GERMANY



SUCCESSFUL R&I
IN EUROPE 2024
11th EUROPEAN
NETWORKING EVENT



Are you research oriented ...

- Fuel consumer on the way to sustainable transport?
 - Explore new fuels and its impact on your environmental footprint and costs
- Fuel / chemicals supplier with pressure to become sustainable?
 - Explore the integration of renewables into your production scheme
 - Find electrolyzer applications that fit into your

Partner search

15 – 16 FEBRUARY 2024
VAN DER VALK
AIRPORTHOTEL
DÜSSELDORF –
GERMANY



SUCCESSFUL R&I
IN EUROPE 2024
11th EUROPEAN
NETWORKING EVENT



Are you research oriented ...

- Fuel consumer on the way to sustainable transport?
 - Explore new fuels and its impact on your environmental footprint and costs
- Fuel / chemicals supplier with pressure to become sustainable?
 - Explore the integration of renewables into your production scheme
 - Find electrolyzer applications that fit into your
- Technology supplier for fuel and chemicals?
 - Explore new process routes that include renewable feedstocks

Partner search

15-16 FEBRUARY 2024
VAN DER VALK
AIRPORTHOTEL
DÜSSELDORF -
GERMANY



SUCCESSFUL R&I
IN EUROPE 2024
11th EUROPEAN
NETWORKING EVENT

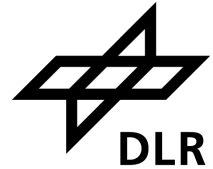

Are you research oriented ...

- Fuel consumer on the way to sustainable transport?
 - Explore new fuels and its impact on your environmental footprint and costs
- Fuel / chemicals supplier with pressure to become sustainable?
 - Explore the integration of renewables into your production scheme
 - Find electrolyzer applications that fit into your
- Technology supplier for fuel and chemicals?
 - Explore new process routes that include renewable feedstocks
- Technology developer for sustainable products?
 - Search for the economic and ecological optimal production
 - Quantify opportunities for improvement, localize bottlenecks
 - Predict new processes market rollout

Thursday, 15. February 2024

Session XX: Mobility

15-16 FEBRUARY 2024

VAN DER VALK
AIRPORTHOTEL
DÜSSELDORF -
GERMANY



SUCCESSFUL R&I
IN EUROPE 2024
11th EUROPEAN
NETWORKING EVENT

THANK YOU FOR YOUR ATTENTION !

QUESTIONS?

**Towards large-scale Deployment
of European Sustainable Aviation Fuels**

**Asif Ansar, Ralph-Uwe Dietrich, Simon Maier, Julia Weyand
(DLR e.V., www.DLR.de/tt)**

