

# Spectroradiometer Calibration for Radiance Transfer Measurements

Clemens Rammeloo<sup>1\*</sup>, Andreas Baumgartner<sup>1†</sup>

<sup>1</sup>German Aerospace Center (DLR), Remote Sensing Technology Institute

\*Now at National Physical Laboratory, Teddington, UK, clemens.rammeloo@npl.co.uk

† andreas.baumgartner@dlr.de

The SI-traceable spectral radiance from the DLR Radiance Standard (RASTA) [1] is transferred to a large integrating sphere with a spectroradiometer (SpectraVista Corp. HR-1024i) [2].

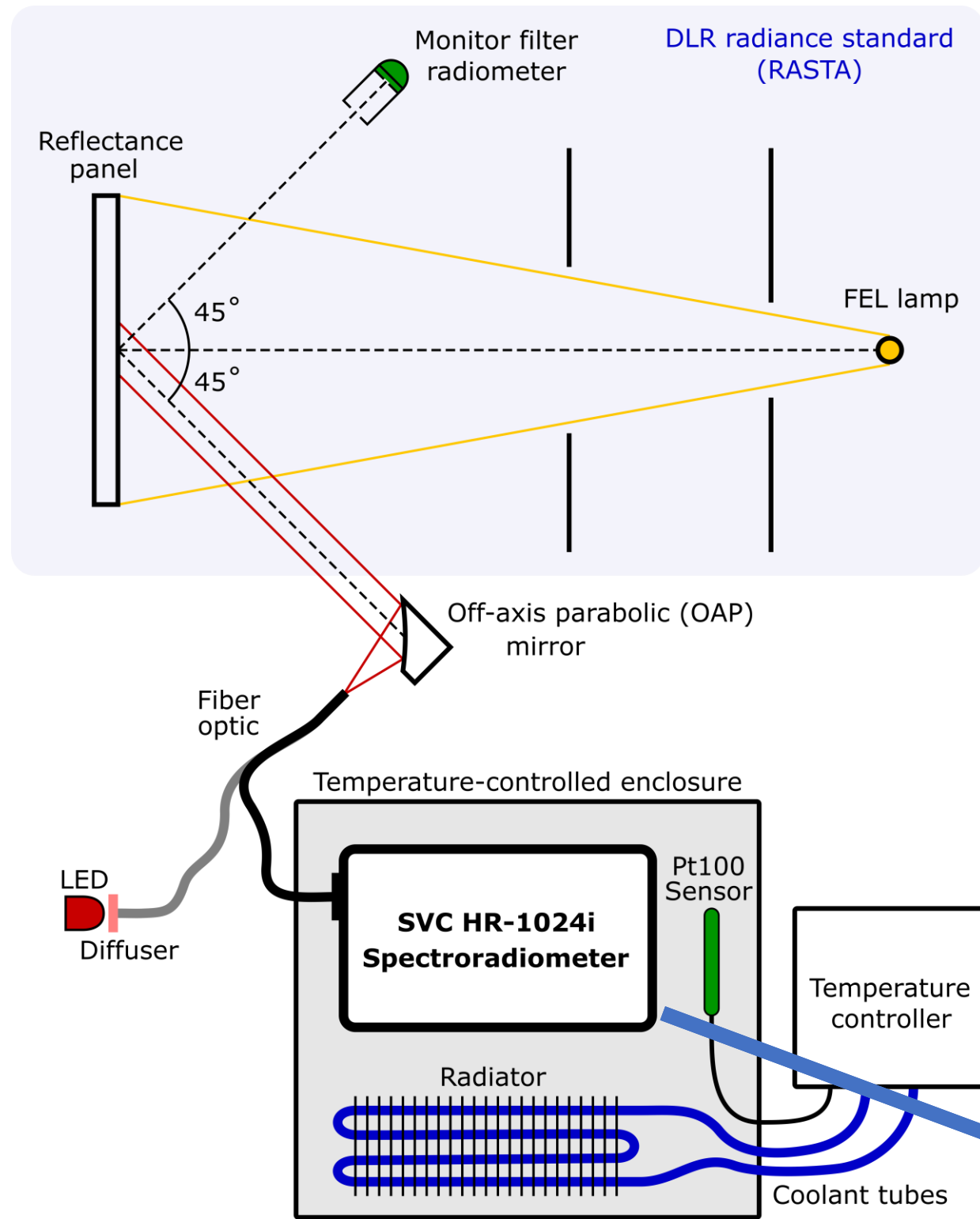

Integrating sphere radiance determined with calibrated spectroradiometer

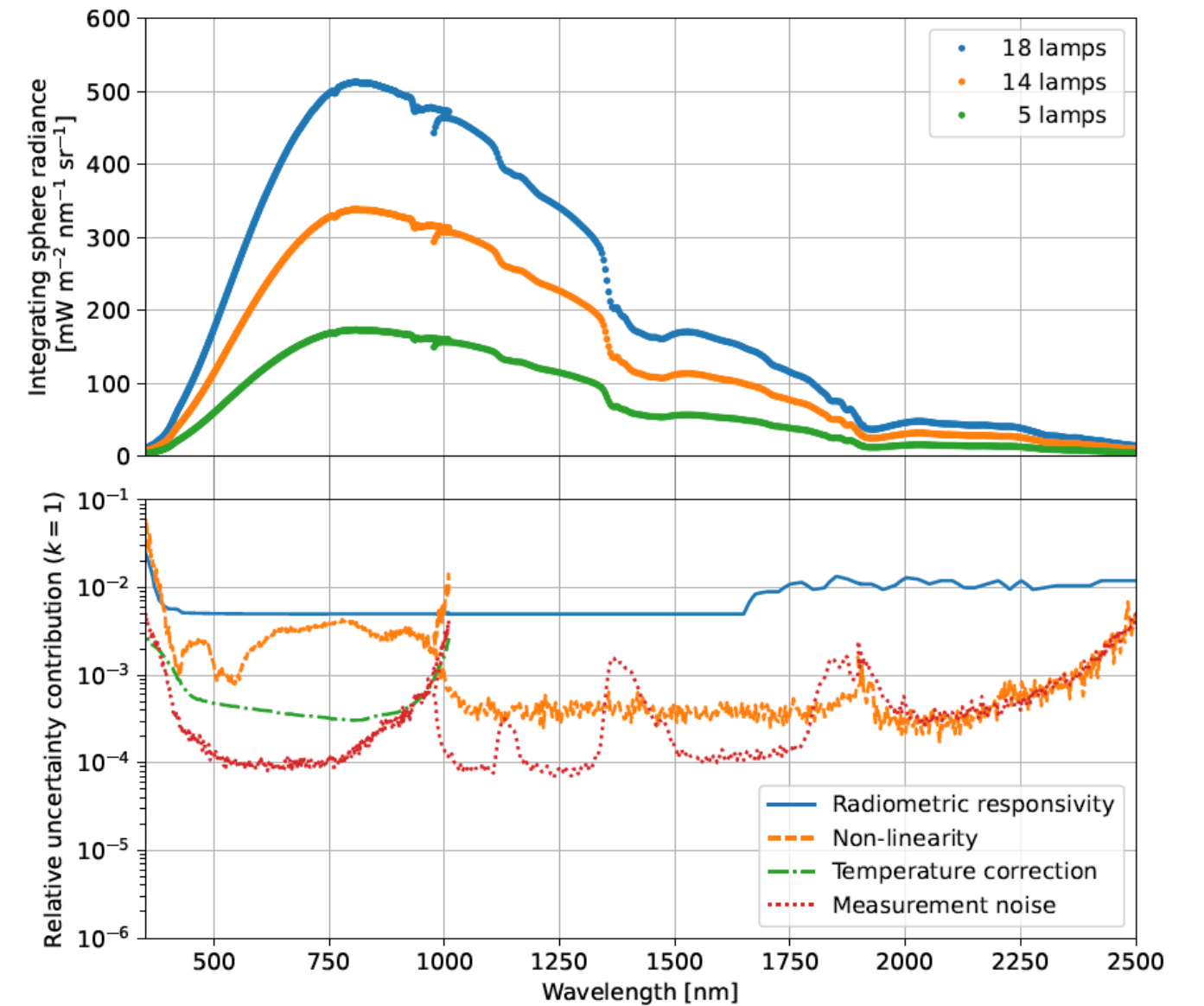
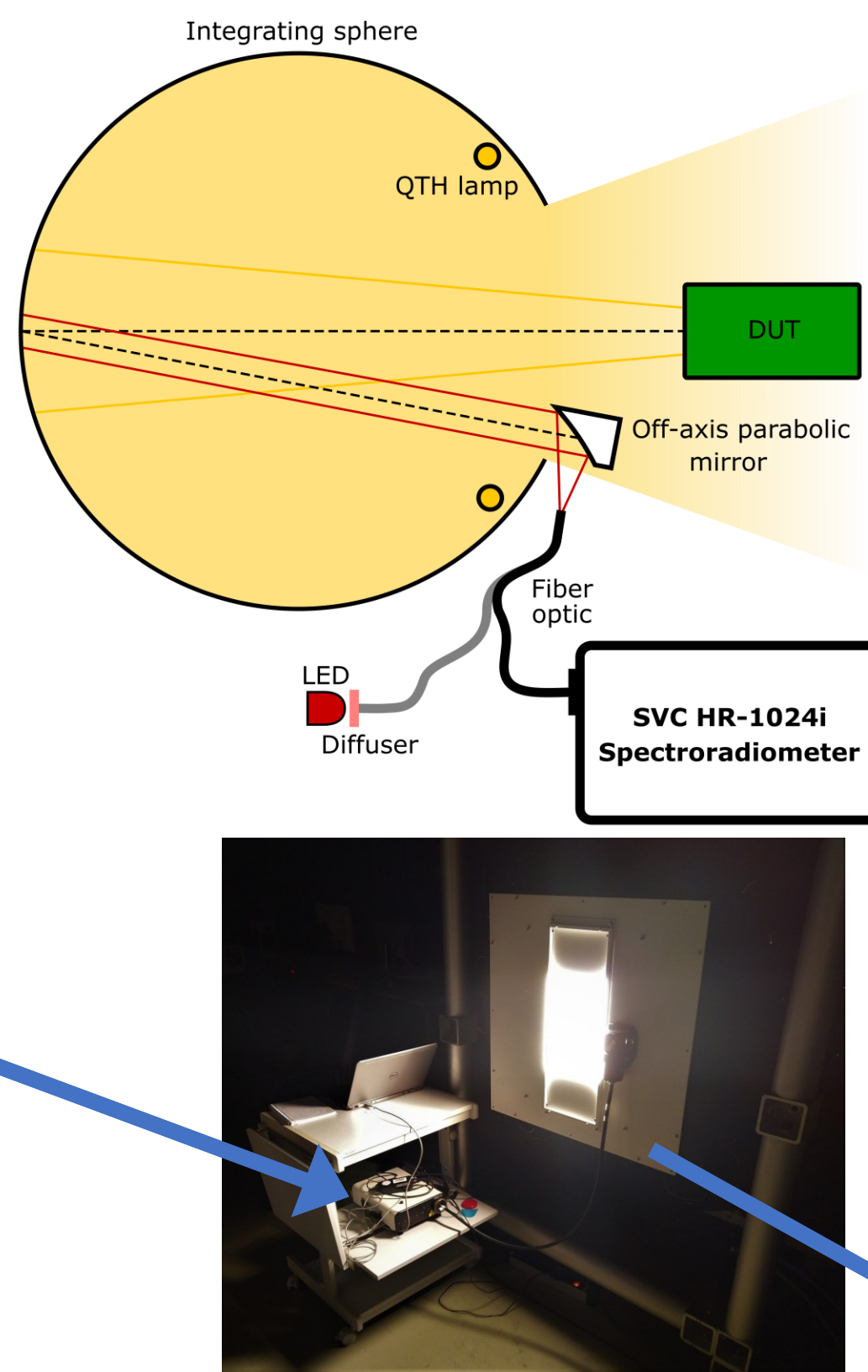

Relative uncertainty in radiance measurements limited by spectral radiance standard to 1% - 3% ( $k = 2$ ).

## Spectroradiometer Measurement Equation

$$S = R t_{int,d} [1 + C_T(T_d - T_{ref})] \int_0^\infty G(\lambda - \lambda_c) L_\lambda(\lambda) d\lambda$$

Signal [DN]    Integration time [ms]    Detector temperature [°C]    Spectral radiance [ $\frac{mW}{m^2 nm sr}$ ]

Radiometric responsivity [ $\frac{DN m^2 nm sr}{mW ms}$ ]    Temperature coefficient [ $1/^\circ C$ ]    Normalised spectral response function (SRF) [ $1/nm$ ]

Traceable radiance from the integrating sphere of the Calibration Homebase [3] is applied in radiometric calibrations of imaging spectrometers, such as:

- APEX [4]
- EnMAP [5]
- specMACS [6]

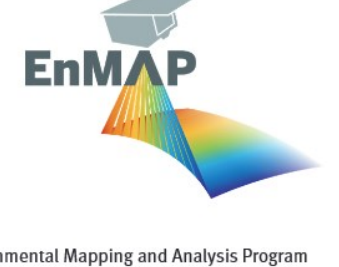

## Radiometric calibration with RASTA

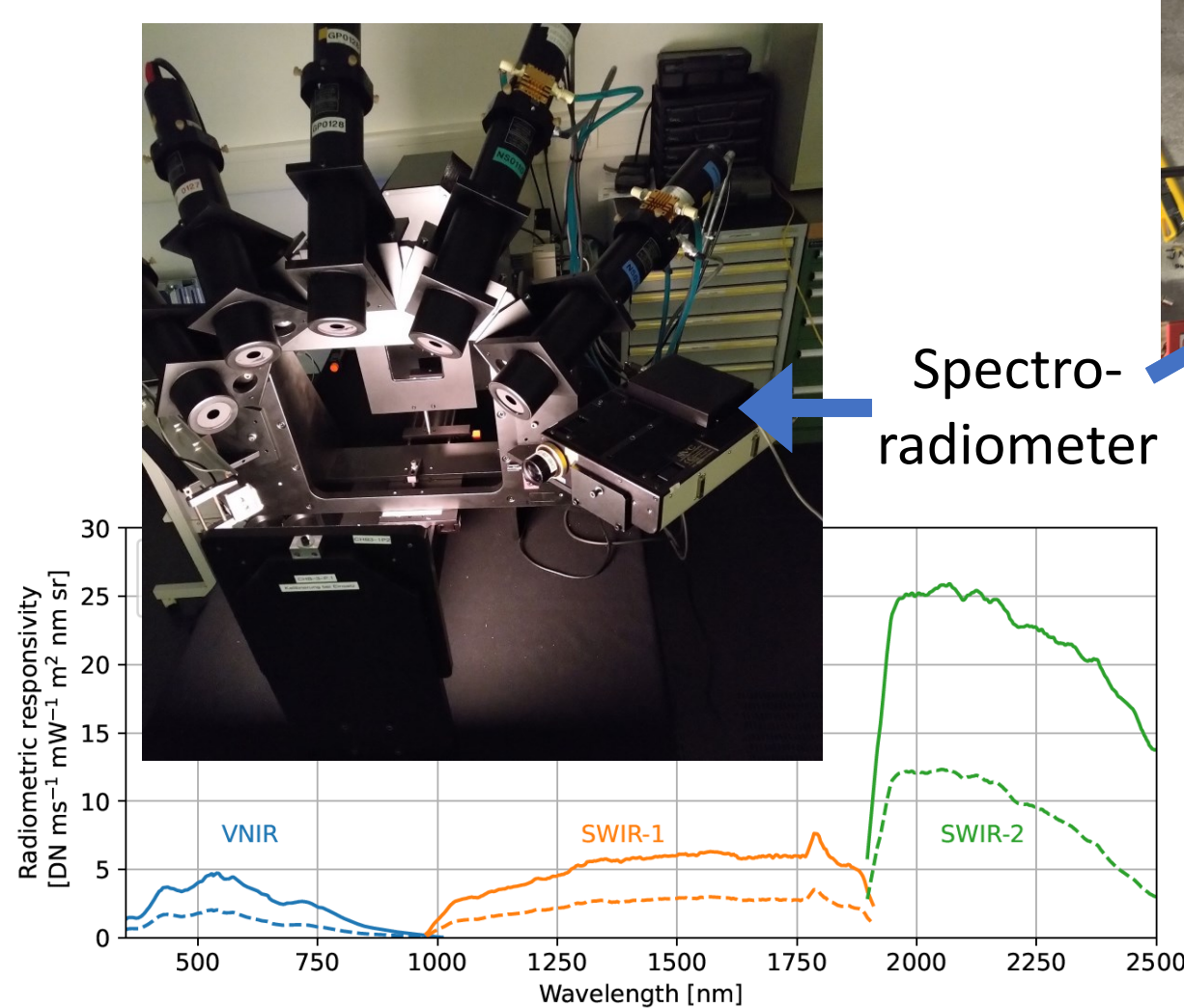

## Temperature dependence measurements

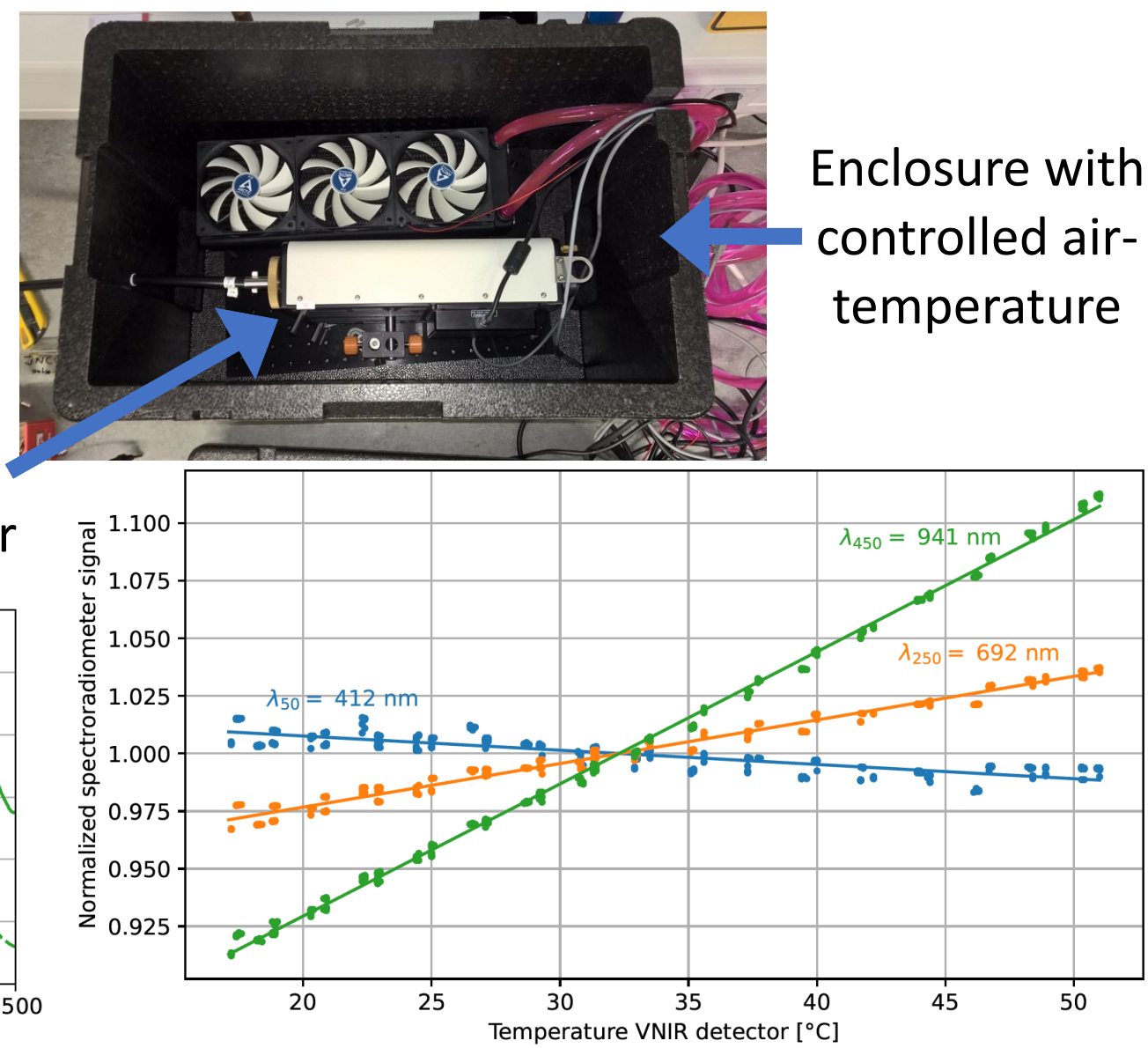

## Spectral response calibration with monochromator measurements

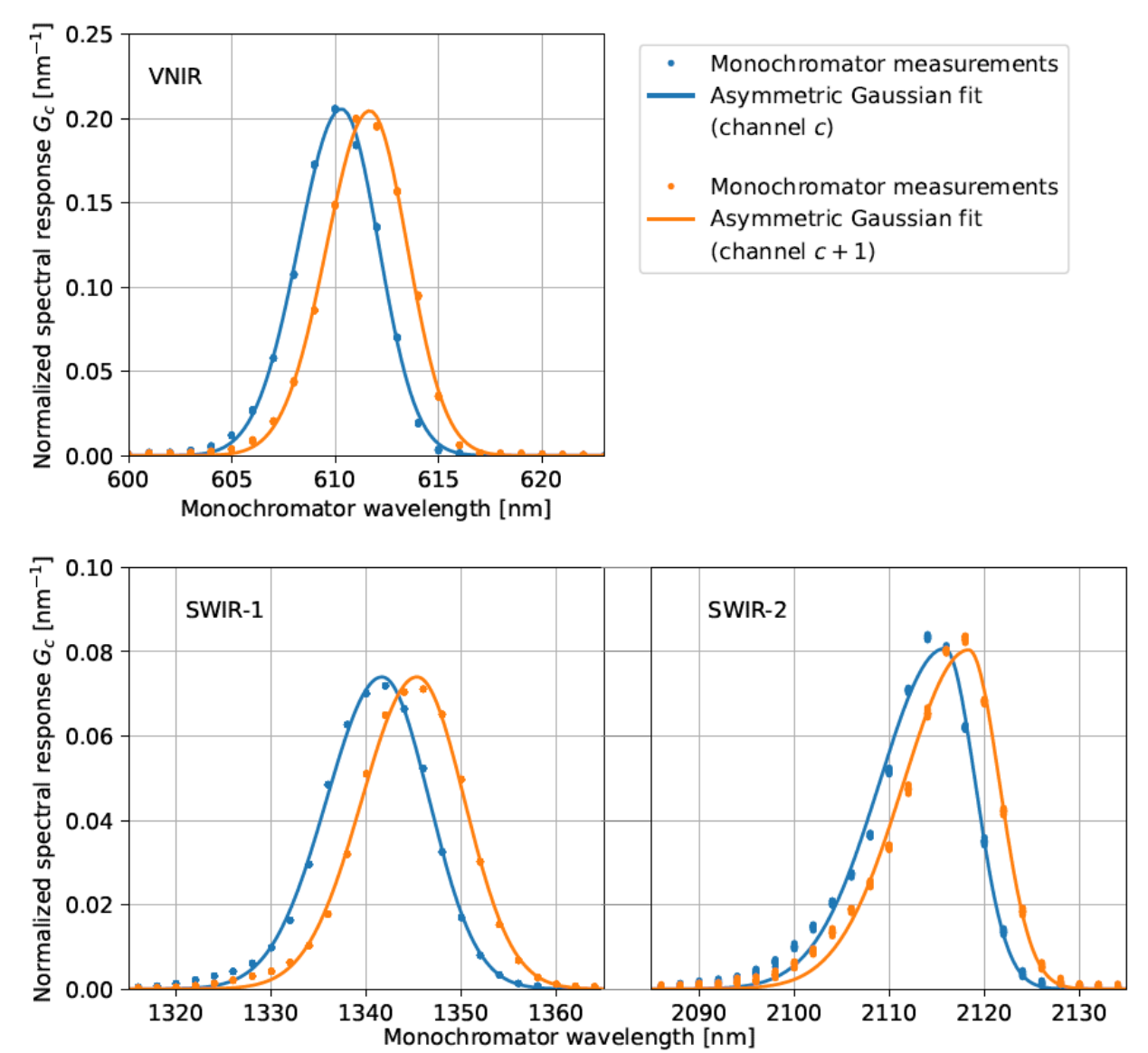

[1] Taubert, D.R.; et al. "Providing radiometric traceability for the calibration home base of DLR by PTB". Proc. AIP Conf. 1531, 376 (2013). DOI: 10.1063/1.4804785

[2] Rammeloo, C.; Baumgartner, A. "Spectroradiometer Calibration for Radiance Transfer Measurements". Sensors 23, 2339 (2023). DOI: 10.3390/s23042339

[3] DLR Remote Sensing Technology Institute. "The Calibration Home Base for Imaging Spectrometers". Journal of large-scale research facilities, 2, A82 (2016). DOI: 10.17815/jlsrf-2-137

[4] Schaepman, M.E.; et al. "Advanced radiometry measurements and Earth science applications with the Airborne Prism Experiment (APEX)". Remote Sens. Environ. 158, 207 (2015). DOI: 10.1016/j.rse.2014.11.014

[5] Polz, L.; et al. "Setups for alignment and on-ground calibration and characterization of the EnMAP hyperspectral imager". Proc. ICSSO Conf. (2020). DOI: 10.1117/12.2600240

[6] Ewald, F.; et al. "Design and characterization of specMACS, a multipurpose hyperspectral cloud and sky imager". Atmos. Meas. Tech. 9, 2015 (2016). DOI: 10.5194/amt-9-2015-2016

