

Highly Efficient RLV-Return Mode “In-Air-Capturing”

Progressing by Preparation of Subscale Flight Tests

*Martin Sippel, Sven Stappert, Leonid Bussler
DLR Institut für Raumfahrtssysteme, Bremen, Germany
Stefan Krause, Sebastian Cain
DLR Institut für Flugsystemtechnik, Braunschweig, Germany
Javier Espuch
Embention Sistemas Inteligentes, SL, Alicante, Spain
Sophia Buckingham
von Karman Institute for Fluid Dynamics VKI, Belgium
Valentin Penev*

Institute of Mechanics – Bulgarian Academy of Sciences (IMech-BAS), Sofia, Bulgaria

An innovative approach for the return of reusable space transportation vehicles has been proposed by DLR: The winged stages are to be caught in the air and towed by subsonic airplanes back to their launch site without any necessity of an own propulsion system. This patented procedure is called in-air-capturing.

The paper describes how “in-air-capturing” works and quantifies performance advantages for RLV. It gives an overview of ongoing experimental and numerical work at DLR in raising the TRL within the project AKIRA. Afterwards, the H2020 project FALCon is explained and early available results are presented. In its final part, the paper proposes a development roadmap on how to bring this efficient RLV technology to reality.

Abbreviations

ACCD	Aerodynamically Controlled Capturing Device	LFBB	Liquid Fly-Back Booster
AoA	Angle of Attack	MECO	Main Engine Cut-Off
CAD	computer aided design	RCS	Reaction Control System
CFD	Computational Fluid Dynamics	RLV	Reusable Launch Vehicle
CoG	Center of Gravity	RTL	Return To Launch Site
DRL	Down Range Landing	TRL	Technology Readiness Level
GLOW	Gross Lift-Off Mass	TSTO	Two-Stage-To-Orbit
IAC	In-Air-Capturing	TVC	Thrust Vector Control
L/D	Lift to Drag ratio	UAV	Unmanned Aerial Vehicle

1. Introduction

Return To Launch Site (RTL) and Down-Range Landing (DRL) are currently employed by SpaceX for the first stages of the Falcon 9 and Heavy launchers, requiring significant amounts of fuel for deceleration and landing. Techniques of turbofan-powered return flight like winged LFBB are more efficient, however, oblige an additional propulsion system and its fuel, which also raises the stage's inert mass. A completely different and innovative approach for the return of RLV-stages with better performance offers the patented “In-air-capturing” (IAC) [1]: The winged reusable stages are to be caught in the air and towed back to their launch site without any necessity of an own propulsion system for this phase [2].

A schematic of the reusable stage's full operational IAC-cycle is shown in Figure 1. At the launcher's lift-off the capturing aircraft is waiting at a downrange rendezvous area. After its MECO the reusable winged stage is separated from the rest of the launch vehicle and afterwards follows a ballistic trajectory, soon reaching denser atmospheric layers. At around 20 km altitude it decelerates to subsonic velocity and rapidly loses altitude in a gliding flight path. At this point a reusable returning stage usually has to initiate the final landing approach or has to ignite its secondary propulsion system.

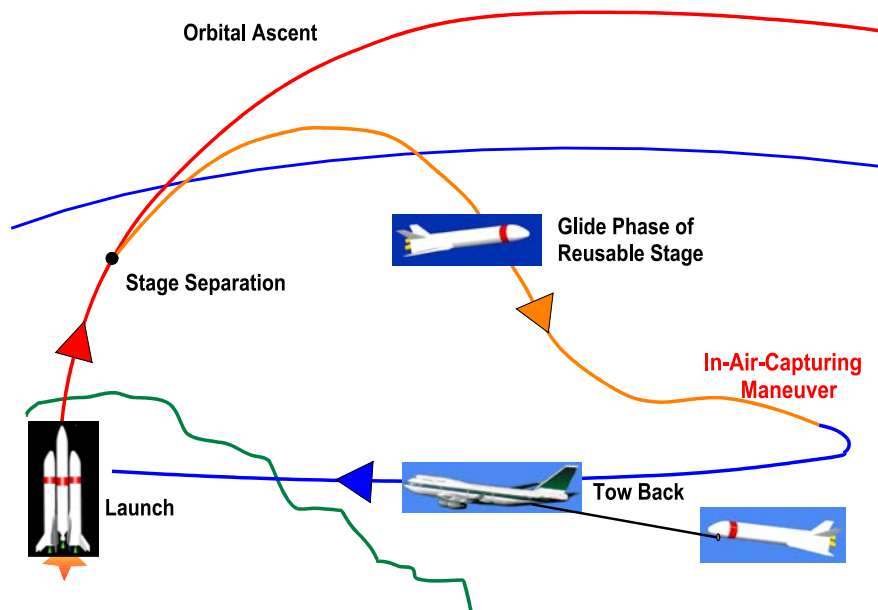

Figure 1: Schematic of the innovative "in-air-capturing"

Differently, within the in-air-capturing method, the reusable stage is awaited by an adequately equipped large capturing aircraft (most likely fully automatic and unmanned), offering sufficient thrust capability to tow a winged launcher stage with restrained lift to drag ratio. The entire maneuver is fully subsonic in an altitude range from around 8000 m to 2000 m [3]. After successfully connecting both vehicles, the winged reusable stage is towed by the large carrier aircraft back to the launch site. Close to the airfield, the stage is released from its towing aircraft and autonomously glides to the landing runway similar to a conventional sailplane.

After DLR had patented the "in-air-capturing"-method (IAC) for future RLVs, two similar approaches have been proposed. However, those named *mid-air retrieval* or *mid-air capturing* are relying on parachute or parafoil as lifting devices for the reusable parts and helicopters as capturing aircraft. The first proposal was made by the Russian launcher company Khronichev [5] and the most recent one by the American company ULA for its newly proposed Vulcan launcher. The ULA proposal intends recovering not more than the first stage's engine bay instead of a full stage [6], [7].

1.1 Potential performance advantage

Any RLV-mode degrades the launcher's performance compared to an ELV due to additional stage inert mass. A comparison of the different performances is of strong interest because these are related to stage size and hence cost. Since a reliable and sufficiently precise estimation of RLV costs is almost impossible today, the performance impact comparison gives a first sound indication of how promising the modes are.

The performance impact of an RLV is directly related to its (ascent) inert mass ratio or net-mass fraction, reasonably assuming that the engine I_{sp} is not considerably effected. Inert masses of the stage during ascent flight are its dry mass and its total residual propellants including all those needed for controlled reentry, landing, and potentially fly-back. A specific inert mass ratio is then defined as:

$$\text{inert mass ratio}_i = \frac{m_{i,\text{inert}}}{GLOW_{\text{stage}}}$$

The higher the inert mass ratio of a stage, the lower is its acceleration performance if propellant type and engine performance are unchanged. Figure 2 shows a comparison of the inert mass ratio for generic TSTO-launchers (design assumptions described in [14]) and different return modes of the reusable first stage. All launchers have been sized for 7.5 tons GTO payload with a variation in separation Mach-number of the RLV [14]. As mission and stage number are identical, the inert mass ratio can be presented as function of the total ascent propellant loading. For better visibility, the propellant combinations are separated in Figure 2: LOX-LH2 (top) and LOX-hydrocarbons methane and RP (bottom). In all presented cases the IAC-stages have a performance advantage not only when compared to the LFBB with turbojet flyback (as already claimed in the past, see [2 - 4]) but also in comparison to the DRL-mode used by SpaceX for GTO-missions. The smaller the inert mass ratio and the smaller the propellant loading for the same mission, the better the system performance and hence potential cost reduction.

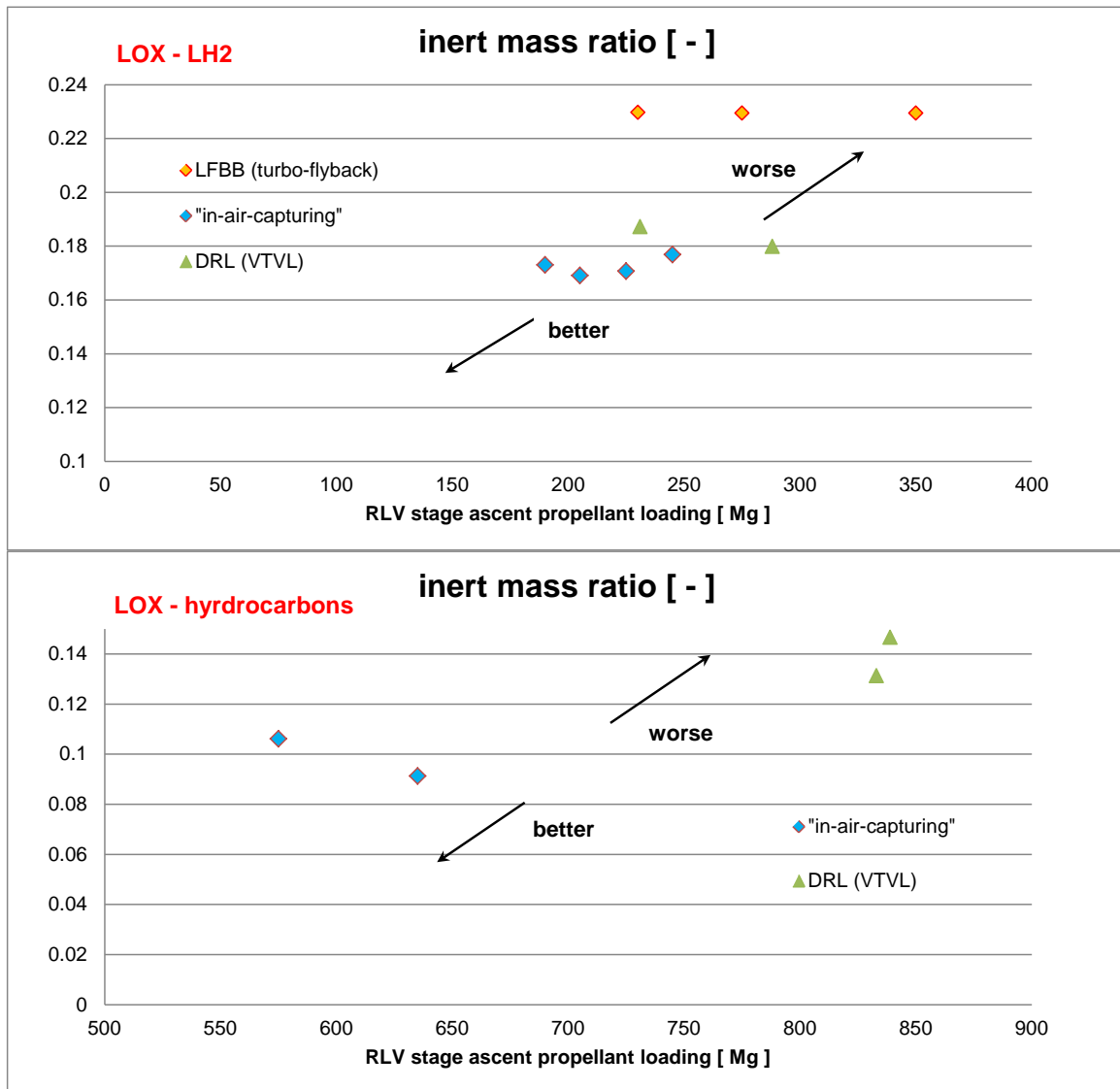

Figure 2: Inert mass ratio depending on RLV-return modes and ascent propellant loading, GTO-mission TSTO (LOX-LH2 top, LOX-hydrocarbons bottom)

A direct comparison between two winged RLV first stages with the same GTO-mission requirement and similar separation Mach-number around 12 but different return-modes has been presented in [16]. The turbofan-powered LFBB mode requires a significantly heavier and larger stage compared to an IAC-mode RLV. The potential for improvement when using the "in-air-capturing"-mode is found between 22% and almost 46% in this example using realistic sizing conditions [16].

1.2 Cost assessment

The stage dry mass of an RLV to be recovered by "in-air-capturing"-method, usually correlated with development and production costs, is reduced by 37% compared to the reference LFBB-configuration [16]. Even when taking into account the additional infrastructure costs of operating the capturing aircraft, the huge cost reduction potential of "in-air-capturing"-RLV compared to more conventional approaches becomes obvious with these numbers.

Recently, a detailed study on operational scenarios of various RLV concept recovery methods has been performed at DLR [17]. This investigation includes the autonomous return flight options LFBB and RTLS as well as the down-range recovery on a sea-going platform (DRL) and "in-air-capturing" by large towing aircraft. All direct costs including personnel, port- or air-traffic-control-fees, and depreciation of the drone ship or the aircraft have been taken into account and have been estimated based on publicly available data of similar vehicles. The preliminary results of the study indicate that both recovery modes DRL and IAC have similar operation expenses of approximately 500 k€ per flight [17, 18]. Refurbishment costs are more difficult to assess at the early development phase of first-stage RLV. A comparison of the mechanical and

thermal loads acting on the stages as presented in [18] will support a more precise estimation of the maintenance costs in the future.

2 How “in-air-capturing” (IAC) works

The winged reusable stages are to be caught in the air, and towed back to their launch site without any necessity of an own propulsion system [2]. The idea has similarities with the DRL-mode, however, initially not landing on ground but “landing” in the air. Thus, additional infrastructure is required: a relatively large-size capturing aircraft – depending on the size of the RLV. Used, refurbished and modified airliners like the Airbus A340 shown in Figure 3 should be sufficient for the task.

A schematic of the reusable stage's full operational cycle has been shown already in Figure 1. At the launcher's lift-off the capturing aircraft is waiting at a downrange rendezvous area. After its MECO the reusable winged stage is separated from the rest of the launch vehicle and afterwards performs a ballistic trajectory, soon reaching denser atmospheric layers. At around 20 km altitude it decelerates to subsonic velocity and rapidly loses altitude in a gliding flight path. At this point a reusable returning stage usually has to initiate the final landing approach or has to ignite its secondary propulsion system.

Differently, within the in-air-capturing method, the reusable stage is awaited by an adequately equipped sufficiently large capturing aircraft (most likely fully automatic and unmanned), offering appropriate thrust capability to tow a winged launcher stage with restrained lift to drag ratio. Both vehicles have the same heading but on different flight levels. The reusable unpowered stage is approaching the airliner from above with a higher initial velocity and a steeper flight path, actively controlled by aerodynamic braking. The time window to successfully perform the capturing process is dependent on the performed flight strategy of both vehicles, but can be extended up to about two minutes. The entire maneuver is fully subsonic in an altitude range from around 8000 m to 2000 m [3, 16]. After successfully connecting both vehicles, the winged reusable stage is towed by the large carrier aircraft back to the launch site. Close to the airfield, the stage is released from its towing aircraft and autonomously glides back to Earth like a sailplane.

2.1 Simulated approach maneuver

After deceleration to subsonic speed at an altitude around 20 km, the winged stage is actively heading towards the capturing aircraft. Under nominal circumstances the latter is assumed to be in a 'passive' mode, just cruising at constant altitude (e.g. 8000 m) and relatively low flight Mach-number of about 0.55 which corresponds to the equivalent earth speed 400 km/h. It has to be assumed that both vehicles are now permanently in communication with each other. During descent the reusable stage is able to perform some position-correction maneuvers and to dissipate kinetic energy, if required. It plays the 'active' part in the approaching maneuver. Plotted data of the flight simulations for the approach maneuver are presented in [3, 16].

The selected flight strategy and the applied control algorithms show in simulations a robust behavior of the reusable stage to reach the capturing aircraft. In the nominal case the approach maneuver of both vehicles requires active control only by the gliding stage. Simulations (3DOF) regarding reasonable assumptions in mass and aerodynamic quality proof that a minimum distance below 200 m between RLV and aircraft can be maintained for up to two minutes [3, 16].

2.2 Potential capturing hardware

The most promising capturing technique is using an aerodynamically controlled capturing device (ACCD), showing the best performance and lowest risk [3, 4]. The ACCD is to be released and then towed by the airplane as in the artist impression in Figure 3. This device contains the connecting mechanism and simply advances towards the stage by its own drag and lift, provided by small wings (typical span 1.5 m). Actuators control the ACCD's orientation and the approaching velocity might be further controlled by braking of the towing rope from inside the aircraft (Figure 4). With an ACCD release initiated at e.g. 230 m distance between the two crafts when both are in parallel descent, the whole maneuver takes about 14 s in the nominal simulated case. All loads at controlled contact remain below 3 g and the final relative velocity is at 5 m/s.

Aerodynamic stability and at the same time sufficient maneuverability of the ACCD during the subsonic capturing process are required. A preliminary configuration has been defined and will be assessed by 6DOF-simulations.



Figure 3: Rendering of Airbus A340-600 large capturing aircraft towing the ACCD (small white dot in the center) which is approaching the RLV-stage in the back, A340-600 picture © AIRBUS S.A.S. 2010

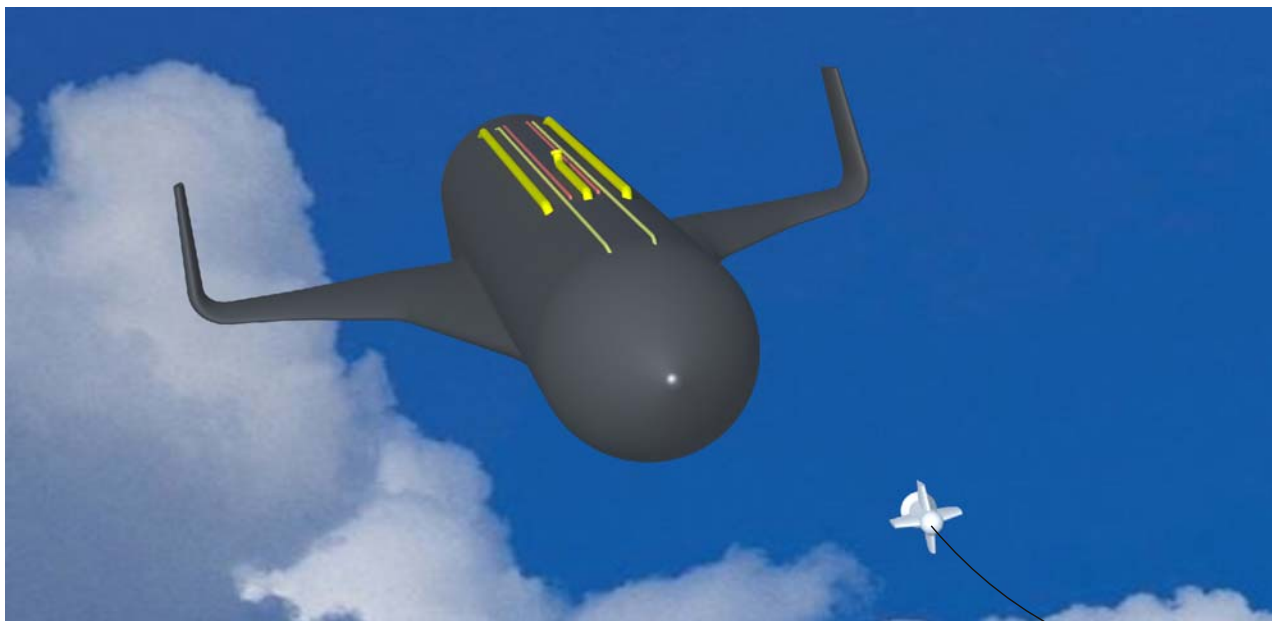

Figure 4: Rendering of ACCD cautiously approaching the RLV-stage shortly before contact

The capturing mechanism inside the ACCD is a critical part which has been preliminarily designed [4] for the static load conditions encountered when capturing and towing a large fictive RLV stage. The mechanism lay-out has to be defined for correct kinematic functioning in capturing-, towing-, and release-mode, as well as for good shock attenuation.

A preliminary design of such a capturing mechanism has been developed (see drawing of internal parts in Figure 5) and has been subsequently mechanically sized supported by Finite-Element stress and deformation analyses [4, 9, 10]. All elements of the mechanism fit into the ACCD fuselage and consist of

- a ball-shaped head with ball jacket,
- industrial shock-absorber,
- different spring and damping elements, and
- additional support structure.

The principal idea of the mechanism is to direct a long passive anchoring device from the RLV to the capturing- and hold mechanism inside the ACCD. A funnel like opening at the ACCD's back with a 30 deg.

cone opening allows for the mechanically steered guidance in case of small flight position imperfections prior to connection and for the required axial deflection between both flying items in the capturing procedure and also thereafter in towing flight. Inside the ACCD all axial loads as well as the relative pitch and yaw movements between the different flight vehicles are transferred through a ball joint to its jacket capable of axially gliding inside the ACCD fuselage.

Figure 5 depicts a suitable design of the ACCD capturing mechanism with major dimensions for a full scale variant capable of connecting to and towing of an 80 tons winged stage. Such an RLV with approximately more than 400 tons GLOW is a good check on the principal feasibility of the capturing devices. This RLV stage is under definition to be used as reference configuration in the recently initiated FALCon-project. Obviously, smaller versions of the ACCD could be sized for reusable stages of reduced scale.

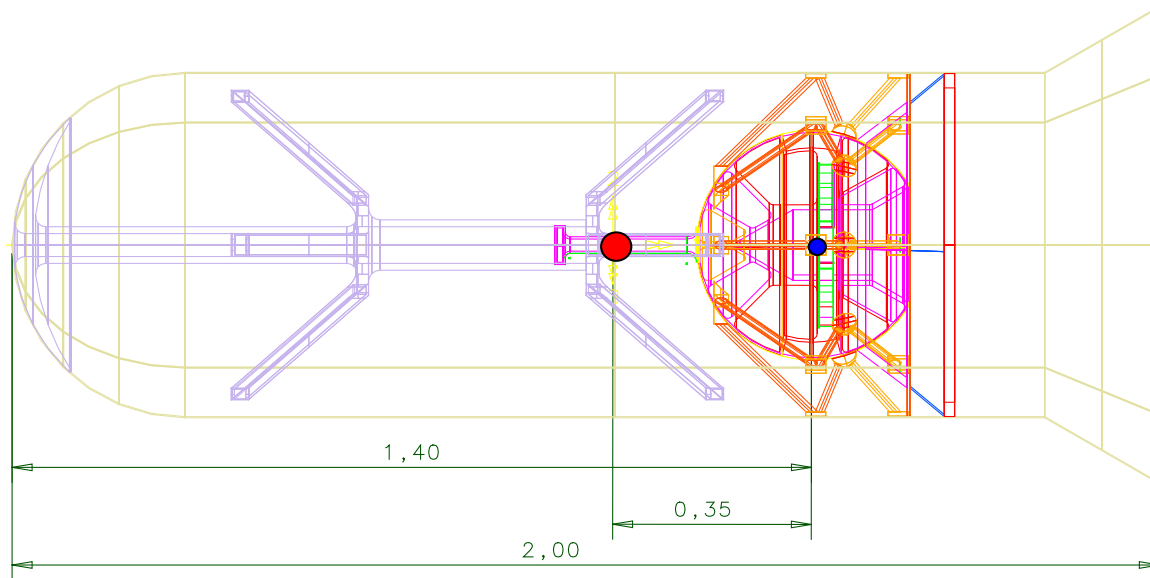

Figure 5: Design drawing of mass optimized capturing mechanism inside the ACCD geometry with major dimensions in [m] [10]

A preliminary investigation of the aerodynamic behavior has been conducted [16] to allow for a first set of 6-DOF simulations of the ACCD in flight. The configuration shall be aerodynamically stable and at the same time allow maneuverability to enable corrections of the ACCD's position and attitude.

2.3 Towing aircraft

Technical requirements of the tow-aircraft are given in [3]. The rope and its mechanism have to be designed to withstand the pulling stress with regard to dynamic loads. The maximum values are most likely being reached during pull-up of the assembly after capturing. A towing rope diameter of 1.6 cm is estimated to be sufficient for up to 200 kN load [3].

The thrust requirements of the capturing aircraft are dependent on the reusable stage's mass and its L/D-ratio. The thrust reserve of the capturing aircraft has to exceed 50 to 200 kN (equivalent to approximately 25 to 80 tons of to be towed stage mass) in an adequate flight altitude [3]. A four engine jetliner without normal cargo loading offers sufficient thrust margins. This is corresponding to an Airbus A-340 or Boeing-747-class jet, which have been produced in large numbers. Moreover, a considerable quantity of these airplanes is available at an affordable price, since significant numbers have been retired from commercial airline service.

Recently, DLR performed a study on different RLV recovery options including technical feasibility assessment as well as estimation of the direct operating costs [17]. To ensure that the aircraft and stage could operate in the towing configuration, the flight envelope was computed as an example for a B747-400 with four CF6-80C2A5 turbofans connected to a generic winged RLV stage of approximately 50 tons return mass. As can be seen in Figure 6, the towing operating point (TOW_{ref}) is well within the limiting speeds. Performance speeds of the RLV-stage and the 747-400 are quite similar (Figure 6), highlighting the suitability of this aircraft for the mission. The relatively high towing altitude and cruise speeds are due to the generous margins of this calculated aircraft-RLV-combination. A check on the towing aircraft robustness concerning a heavier RLV with lower maximum trimmed L/D confirmed suitability of the B747 resulting in a slightly reduced flying envelope with lower maximum ceiling [17].

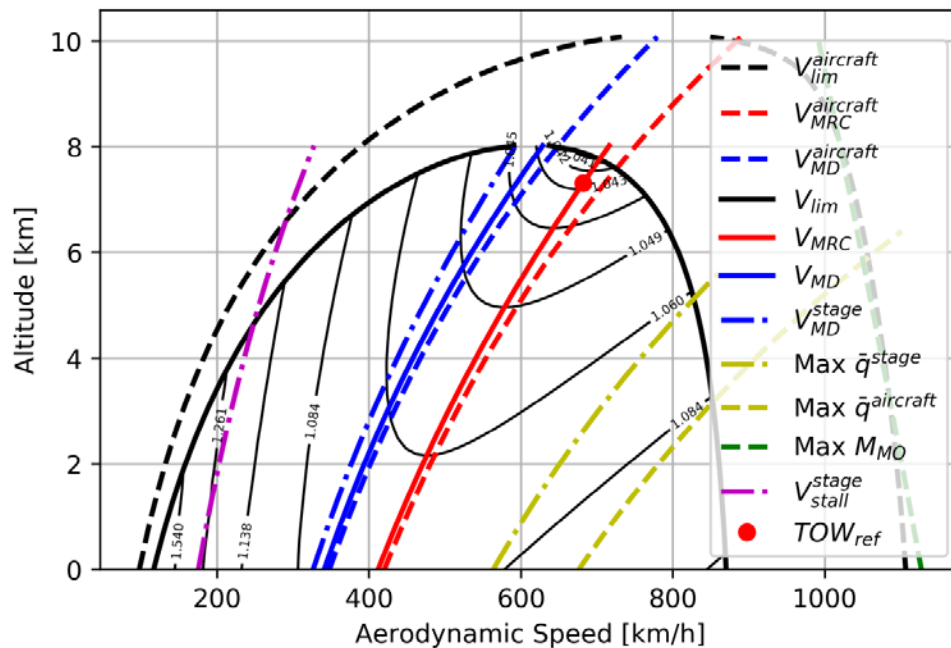

Figure 6: Calculated flight envelope for B747-400 and typical RLV-first stage towing configuration [17]

A catastrophic mid-air collision has to be avoided by fully automatic and redundant control avionics of both vehicles operating in a synchronized mode. Any pilot interference in this maneuver from the capturing aircraft would be far too slow, to have a positive impact. Since no real demanding pilot work is foreseeable, one should seriously consider redesigning the capturing and towing aircraft as an unmanned aerial vehicle. Taking into account the significant progress recently achieved in UAV avionics, this is not an exotic idea.

An unmanned towing aircraft will augment overall reliability and safety of the in-air-capturing method. The certification process of the large unmanned vehicles is to be addressed early in the design phase. As the full capturing mission is to be performed exclusively over uninhabited areas off-shore of a launch site, the required certification is currently not assessed as a blocking point.

3 AKIRA lab-scale flight experiments

DLR in its internal project AKIRA [11] is moving on from pure simulations to lab-scale flight experiments [12] aiming for a TRL between 3 and 4. Work was initiated in early 2017 and will finish end of 2019 when a full transition to the new project FALCon is reached.

The first validation during the lab-scale flight experiments are performed using smaller unmanned aircraft. One will tow the coupling device and a second will represent the booster stage. This poses certain boundary conditions, especially on the weight of the towed device, as the UAVs have limited excess power to perform the tow. Also the experiments must be performed on a racetrack course instead of a straight track for safety reasons and although the coupling maneuver will be demonstrated, the actual tow of the aircraft is not a part of the AKIRA-experiments.

3.1 Subscale coupling device

Establishing connection between the RLV-stage and the large carrier aircraft requires formation flight of both vehicles during the approach maneuver. Actual coupling is best achieved by a highly agile connecting device or coupling unit with onboard actuators like the above discussed ACCD.

For its basic functionality, the subscale coupling device consists of a cone, ensuring the stable flight behavior by its own drag and four control surfaces, which deflect for roll, vertical and horizontal movements as shown in Figure 7.

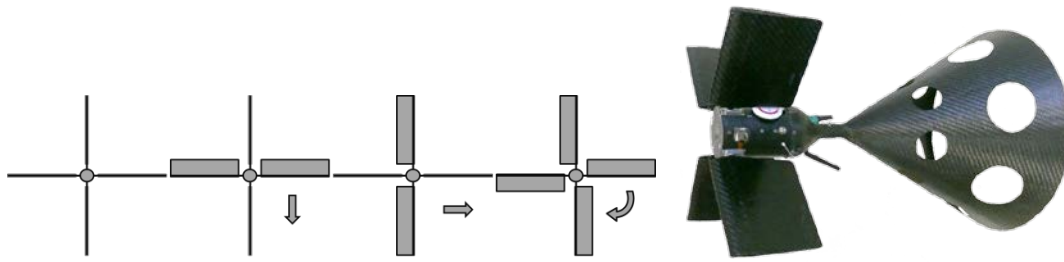

Figure 7: Surface deflections for ACD control (left) and prototype device (right)

For automatic control of the ACD, avionics, consisting of sensors and a control computer (including data logging), telemetry, actuators and a power source are required. The ACD is completely equipped with control computer, telemetry and power source, actuators and sensors. This configuration has been chosen for the reason of better flexibility despite the challenge of increased weight of the device.

For the experiments a demonstrator of the coupling device (Figure 7 at right) was build. The main material is CRFP to remain as lightweight as possible. Table 1 summarizes some basic data of the device.

Table 1: Key parameters of the test coupling device

length	≈ 450 mm
cone diameter	370 mm
weight (incl. avionics)	650 g
control surface span (each)	120 mm
control surface width (each)	100 mm
maximum control deflection	+/- 45°

The avionics consist of a commercial Pixhawk autopilot system which comes with various equipment and sensors, as a u-blox M8N GPS with compass module, 433 MHz telemetry, RC receiver, UBEC voltage regulator and a voltage monitor for the battery and already provides a way for internal logging of flight data. The control system is realized by adapting the commonly used autopilot software of the Pixhawk hardware. More information on the avionics and flight controls is provided in reference 13.

3.2 Flight evaluations

The build and controlled device was tested for its functionality in ground runs and in flight tests towed by an aircraft (Figure 8) but without connecting to the 2nd UAV. With the enabled roll stabilization the possible deflections were evaluated.

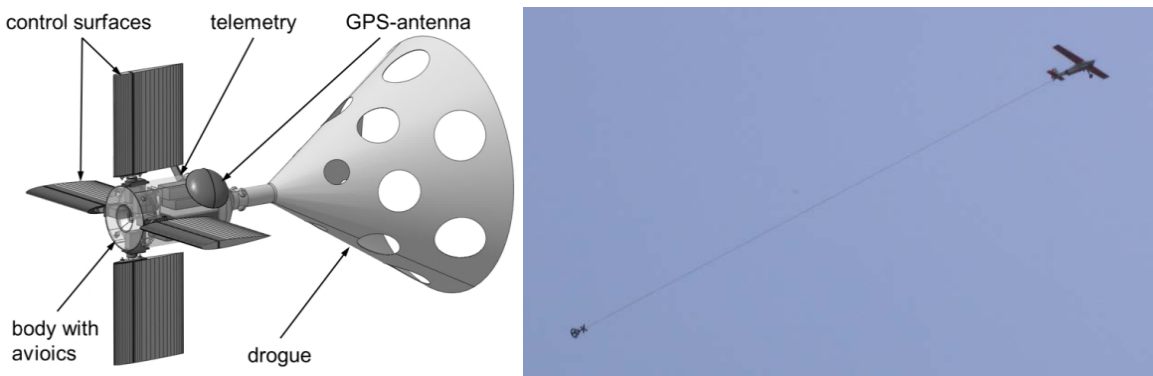

Figure 8: Coupling unit (left) and in flight test (right) with towing UAV "MAL" of DLR

Typical results of the tests are shown in Figure 9 for horizontal movements and vertical movements. For these experiments the roll stabilization commands were mixed with control inputs from a remote controller. The displacements can be evaluated from the changes in height offset between coupling device and tow aircraft for the vertical movements and the offset of the coupling device to the flown aircraft track for the horizontal movements. Due to heavy wind conditions only short inputs could be evaluated during the tests.

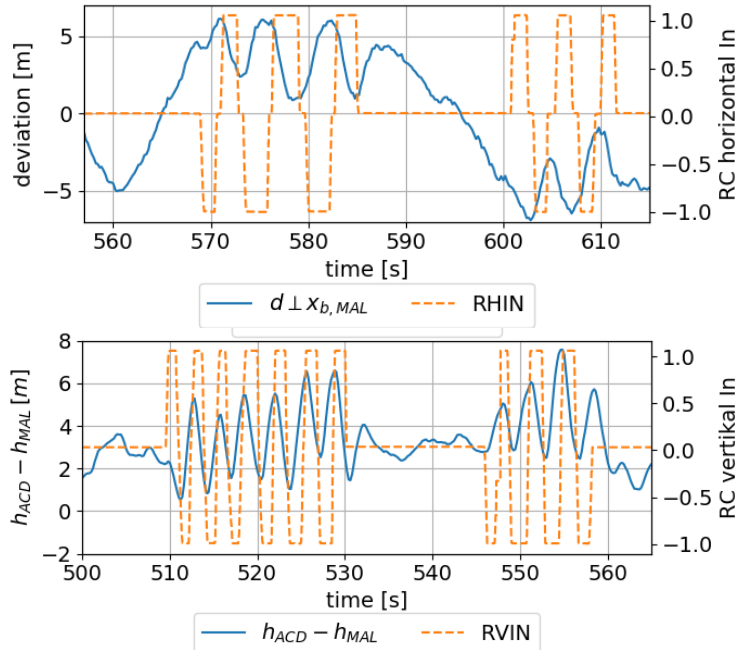

Figure 9: Horizontal (top) and vertical (bottom) displacement during control inputs [13]

The first evaluation showed satisfying results for the coupling device movements from 2.5 m to 3 m per side which spans a 6 m x 6 m frame for positioning. Especially when regarding the wing span of the towing vehicle which is in the same size as the movements, this seems to enable for sufficient maneuvering.

As next step for performing the in-air capturing demonstration, a GNSS based formation between two vehicles based on a communication link has been set-up. The resulting error from the GNSS data is expected to be within the positioning capabilities of the coupling device. Two commercial autopilots are used which are modified for the formation flights. One is set to be the 'master' system which sends waypoint and speed commands to the 'slave' system. These waypoints contain a relative position based on the navigation data of the master system. Flights are performed using two very lightweight test vehicles (takeoff mass <3 kg, Figure 10) to keep the risk and effort at a minimum. These planes are nevertheless fully equipped to perform automatic missions and capture video data. Experiments with such a communication established have been completed and the evaluation showed good reproducibility and stable formation flight up to 60 s with controlled distances between 10 m and 40 m.



Figure 10: Test vehicles for automated formation flight testing

In parallel work the detection of the position from the device with respect to the reusable stage demonstrator is done. This is realized by camera and laser based environment perception at the RLV-stage demonstrator. The reason for equipping the sensors on this vehicle is simply due to the weight limitation of the device. In a real scenario it would probably be feasible to directly equip the coupling device.

4 H2020 research project FALCon

In order to accelerate the development of “in-air-capturing”-technology, a new Horizon 2020 project with the name FALCon (**F**ormation flight for in-**A**ir **L**auncher 1st stage **C**apturing **d**emonstration) has been kicked-off in March 2019. With its scheduled duration of 36 months and with total funding of 2.6 M€ the FALCon project will address three key areas:

- “in-air-capturing”-Development Roadmap and economic benefit assessment
- “in-air-capturing”-Experimental Flight Demonstration
- “in-air-capturing”-Simulation (subscale and full-scale)

Table 2 gives a list of the partners involved in FALCon. Three of them are from the aerospace and mechanical research area (DLR, VKI and IMech-BAS) while the other four are European SME.

Table 2: List of FALCon project partners

Participant No	Participant organization name	Country
1 (Coordinator)	Deutsches Zentrum für Luft- und Raumfahrt (DLR)	Germany
2	Institut von Karman de Dynamique des Fluides (IVKDF, VKI)	Belgium
3	Drone Rescue Systems GmbH	Austria
4	Soft2tec GmbH (S2T)	Germany
5	Astos Solutions SRL (ASTOS)	Romania
6	Institute of Mechanics, Bulgarian Academy of Sciences (IMech-BAS)	Bulgaria
7	Embention	Spain

4.1 Flight testing preparation

The experimental test and validation processes in FALCon are the key objectives of the project. Half of all the workpackages are dedicated to this goal. The to be captured RLV-stage demonstrator will be completely designed and built from scratch while DLR introduced a new tow aircraft with funding outside of FALCon (Figure 11). The coupling unit will be a redesigned and upgraded version of the device developed and used in the AKIRA project. An integrated communication and data fusion strategy will be developed in FALCon. A sensor package is to be integrated into the flight experiment coupling unit with an infrared camera system in combination with optical markers. The hardware including on-board computers must be lightweight for not influencing the flight performance but powerful enough to run the state machine and the formation algorithms.



Figure 11: New DLR UAV APUS

Embention is defining the RLV scale model aircraft that will be used to simulate the in-air capturing maneuver. A representative vehicle geometry will be inspired by a proposal from DLR: a double-delta configuration based on typical RLV stage design with a large blunt base area (Figure 12). The intended subsonic

trimmed L/D should be > 6 and x-CoG position $\approx 70\%$ from the nose. The integration of speed brakes (e.g. in the vertical stabilizer) is recommended.

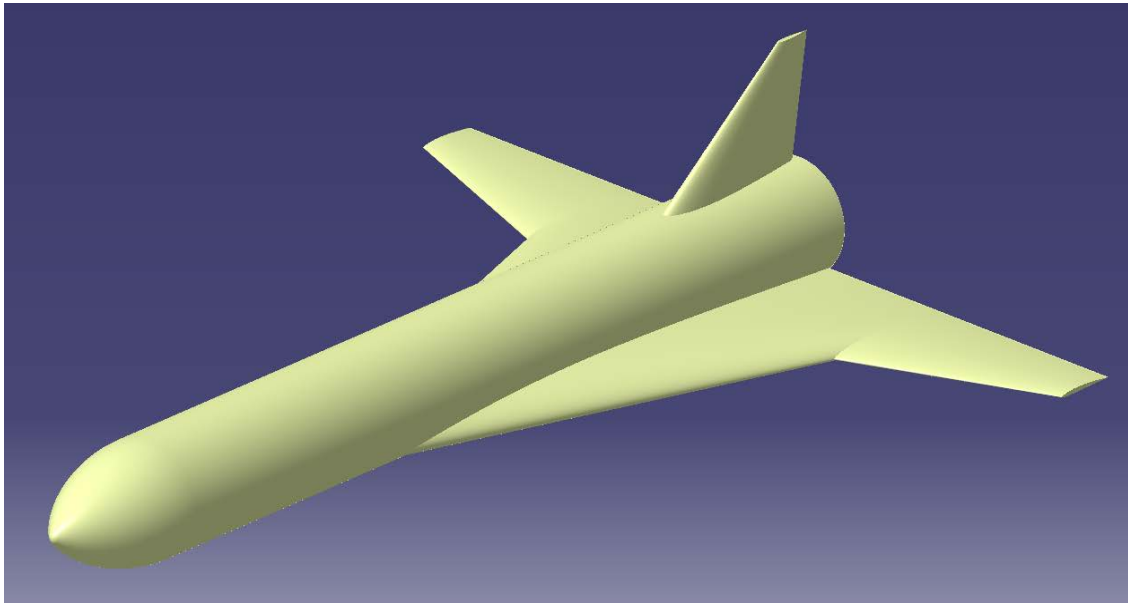

Figure 12: Proposed RLV scale model in CAD

The vehicle recovery maneuver has been analyzed in order to select the appropriate aircraft dynamics and propulsion system to be used to simulate the capturing in the scaled scenario. The mission has been defined so the RLV scale model flies in autonomous mode during the whole mission. The Veronte autopilot will handle aircraft control dividing the mission in five phases. The aircraft will perform a runway take-off before starting the ascent in spiral flight mode. Once the specified altitude has been reached it will stop the motor and glide at a given flightpath angle, simulating a typical unpowered launch vehicle glide path. Once the connection and towing demonstration phase have been completed the RLV scale model will initiate a landing phase in a safe area.

Evaluation between DLR and Embention is ongoing on how to best perform the formation flight between both vehicles. The later technical implementation partly depends on the used autopilots (A/P). It is currently under evaluation if the Embention A/P can be used for the tow demonstrator as well.

To enable a later integration of the single models in a common simulation framework/environment, DLR provided general requirements of the simulation environment and exemplary 'containers' for the integration of the submodels to be used by IM-BAS. The flight dynamic requirements have been announced by DLR for the demonstrators including an airspeed range from 20 m/s to 70 m/s and take-off weight from 12 kg to 40 kg.

The Simulink (especially Aerospace Toolbox and Aerospace Blockset) block diagram environment for multi-domain simulation was used for the development of the models (Figure 13).

The implementation of these models and the simulation of their approximated behavior require a good knowledge about the vehicle geometries. As this information is not available at the current state of the project, the models and the behavior simulation have been developed on known exemplary partial geometries and partial flight envelope of generic UAV configurations. Based on experience from previous projects, several UAV aerodynamics are available. These aerodynamic models have been calculated with the software TORNADO (vortex lattice method in the environment of MATLAB) and are the basis to develop flight dynamic models of the FALCon-demonstrators.

For each demonstrator three flight dynamic models have been created with different levels of fidelity. Two of these models are nonlinear and the third is linear. The nonlinear model is used to precise the flight control systems of the vehicles. A requirement is that the trimmed condition and the open loop system response are well known. If the nonlinear model generates decent results, the linear model can be used afterwards for the mission scenario test. The current generic model provides a good assumption for first simulations.

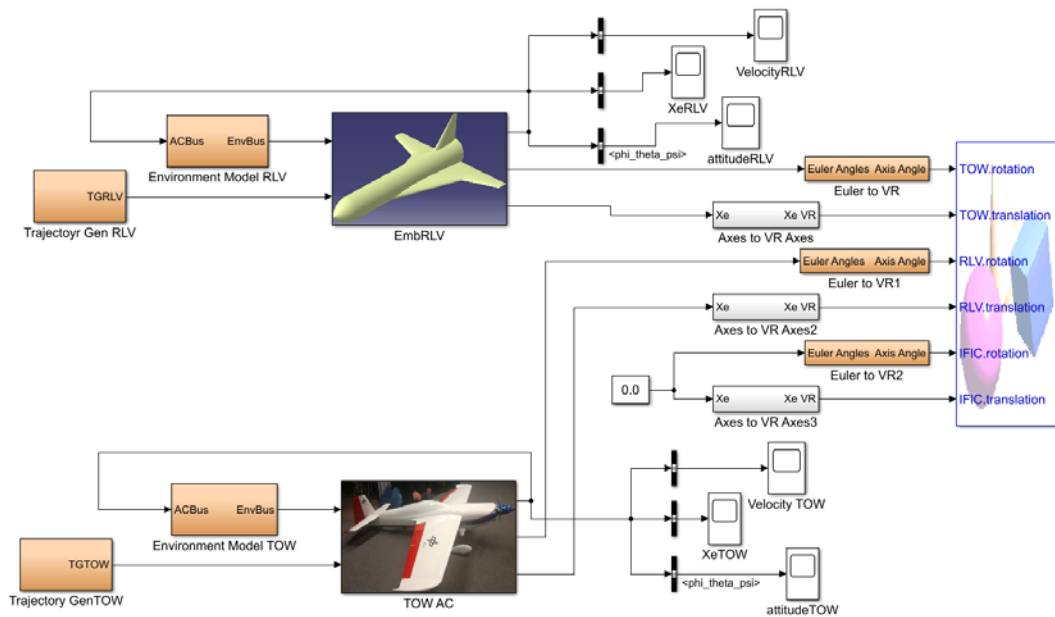

Figure 13: Simulink block diagram environment for multi-domain simulation

4.2 Experiment and full-scale simulations

Adequate simulation of the “in-air-capturing”-process is the other key-element to increase its TRL in FALCon. This is done in two workpackages which should have a close interaction and fruitful exchange of requirements, methods and procedures. Experiment simulation is supported by windtunnel tests in subsonics at VKI. Return simulation of full-scale RLV first stages is enabled by CFD calculations of the flow field around the three full-scale vehicles/objects in formation flight and the dynamic modeling of all these vehicles including the flexible dynamics of the towing rope.

One of the key subtasks of the FALcon project is to establish an accurate multi-body simulation environment for modeling the “in-air-capturing”-flight scenario. It will integrate all modules (i.e. sensors, flight mechanics of each vehicle) in a single multi-body framework for further development of the “in-air-capturing” procedure. This environment will be used for both the planned flight tests and the full-scale RLV first stage return mode.

The aerodynamic parameters are among the essential inputs required by the flight dynamic models, and are currently based on low fidelity aerodynamic tables [16]. The work performed by the von Karman Institute (VKI) consists in revising this aerodynamic database so that high fidelity aerodynamic tables can be used to compute the forces and moments acting on the multi-vehicle scenario. On one-hand, wind tunnel tests will be performed to precisely measure the aerodynamic performance of the subscale coupling unit. As a result, a more refined simulation of the “in-air-capturing” technology with subscale vehicles can be proposed in preparation to the flight demonstration.

On the other-hand, Computational Fluid Dynamics (CFD) calculations are being carried out on the full-scale coupling device to extract thereof high fidelity aerodynamic coefficients to be used as input while simulating the multi body “in-air-capturing” return mode in real flight conditions. The methodology that is being implemented uses the *snappyHexMesh* utility of OpenFOAM for mesh generation and its compressible framework to resolve the steady flow field around a preliminary design of the ACCD. Non-reflective boundary conditions have been implemented to numerically absorb the acoustic waves at the outlet, thus preventing these from being reflected back towards the zone of interest. CFD results will be used to examine the stability of the initial ACCD design, and possibly propose geometry adaptations or additional surfaces to improve controllability. This CFD framework will serve as the basis to simulate the three full-scale vehicles, allowing the investigation of the flow field interactions between them in formation flight and its impact or sensitivity on the flight controls.

4.3 Roadmap for future implementation

The development roadmap for “in-air-capturing” is to be defined in cooperation with the European stakeholders e.g. ESA, CNES, ONERA, CIRA, VKI, and industrial primes. This process will consider the classical Technology Readiness Level (TRL) definition (e.g. [15]). Although, the TRL-approach is helpful, it has

been found not necessarily sufficient for successful development of RLV. Therefore, a NASA working group has proposed a "Phased Development Approach (PDA) using Integration Readiness Levels (IRLs) to facilitate selection, sequencing and staging of flight test demonstrations to reduce the risks inherent in technology development." [15] Exactly this methodology will be implemented in FALCon for the establishment of the "in-air-capturing" roadmap.

Starting point of all activities concerning "in-air-capturing" is the most recent technology development status from the ongoing DLR AKIRA-project [11]. Results on IAC from this activity are available to FALCon-project partners. Completion of AKIRA will also finish PDA Phase 1 and will approach a TRL of 4. The Horizon2020 FALCon-project will initiate PDA Phase 2, will consolidate the TRL of 4 and is planned to bring all relevant technologies close to a TRL of 5.

Based on the achievements in FALCon (e.g. better, more accurate simulations, windtunnel measurements, sensor data integration procedures, etc.), the next demonstration steps are in-flight verification of the RLV-demonstrator, of the capturing aircraft and of the coupling unit to confirm the aerodynamic qualities, ballistic coefficients and control margins of the system. At this stage the TRL of 6 and system integration IRL between 1 and 2 will be achieved. Funding could be provided by relevant ESA technology development programs like FLPP which are considered as a suitable framework.

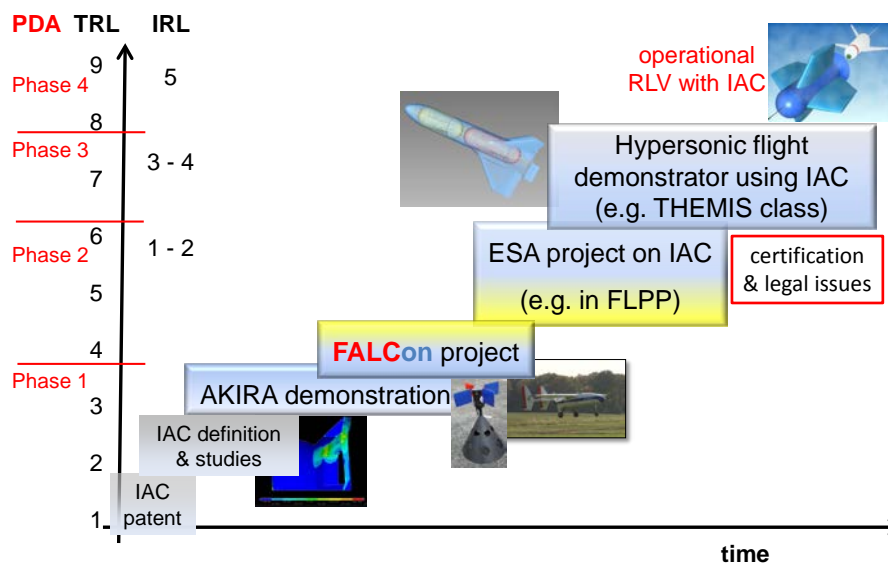

Figure 14: "in-air-capturing"-Development Roadmap

5 Conclusion

The innovative method for the return to the launch site of reusable winged stages by "in-air-capturing" is described and its major advantage of increased payload mass to orbit is quantified for different missions and RLV-separation conditions.

The selected flight strategy and the applied control algorithms in 3DOF-simulations show a robust behavior of the reusable stage to reach the capturing aircraft. When considering reasonable assumptions in mass and aerodynamic quality of the vehicles, a minimum distance below 200 m can be maintained in the formation flight simulations for up to two minutes.

The most promising capturing technique is using an aerodynamically controlled capturing device (ACCD), showing the best performance and lowest risk. A capturing mechanism has been preliminarily designed for the ACCD. The structural parts have been pre-dimensioned for two static load cases supported by finite element calculations. Component masses have been minimized by iterative resizing. Technical requirements of the tow-aircraft have been reassessed and a flight envelope for a typical configuration has been defined.

DLR is currently progressing with the "in-air-capturing"-technology by performing lab-scale flight experiments aiming for a TRL between 3 and 4. The new European research projects FALCon within Horizon 2020 has been kicked-off in March and will bring the TRL beyond 4 in 2021. Subsequently, the advanced method is to be refined in more complex integrated systems of increased scale bringing "in-air-capturing" to operational reality.

Acknowledgements

Part of this work was performed within the project 'Formation flight for in-Air Launcher 1st stage Capturing demonstration' (FALCon) addressing development and testing of the "in-air-capturing" technology. FALCon, coordinated by DLR-SART, is supported by the EU within the Horizon2020 Programme 5.iii. *Leadership in Enabling and Industrial Technologies – Space* with EC grant 821953. Further information on FALCon can be found at <http://www.FALCon-iac.eu>

The authors would like to acknowledge Guillermo Calabuig for the work contributed to this paper.

References

1. Patentschrift (patent specification) DE 101 47 144 C1, Verfahren zum Bergen einer Stufe eines mehrstufigen Raumtransportsystems, released 2003
2. Sippel, M.; Klevanski, J.; Kauffmann, J.: Innovative Method for Return to the Launch Site of Reusable Winged Stages, IAF-01-V.3.08, 2001
3. Sippel, M., Klevanski, J.: Progresses in Simulating the Advanced In-Air-Capturing Method, 5th International Conference on Launcher Technology, Missions, Control and Avionics, S15.2, Madrid, November 2003
4. Sippel, M.; Klevanski, J.: Simulation of Dynamic Control Environments of the In-Air-Capturing Mechanism, 6th International Symposium on Launcher Technology 2005, B1.4
5. Antonenko, S.; Belavskiy, S.: The mid-air retrieval technology for returning of the reusable LV's booster, 2nd EUCASS, 1.03.08, July 1-6, 2007
6. <http://spaceflightnow.com/2015/04/14/ula-chief-explains-reusability-and-innovation-of-new-rocket/>
7. Les Kovacs: ULA REUSABILITY INITIATIVES, presentation at Space Tech Bremen, 24.10.2017
8. Schlögl, B.: Systematische Analyse von Ankopplungsverfahren zum Bergen einer wiederverwendbaren Raumtransporterstufe in der Luft, SART TN-008/2003, DLR-IB 647-2003/11, October 2003
9. Heide, J.: Auslegung eines Kopplungsmechanismus für das In-Air-Capturing Verfahren, SART TN-004/2005, DLR-IB 647-2005/10, March 2006
10. Atanassov, U. : Finite-Elemente-Analyse des 'in-air-capturing'-Mechanismus mit dem Programmsystem I-DEAS, SART TN-005/2006, DLR-IB 647-2006 / 06
11. Sippel, M.; Stappert, S.; Wilken, J. ; Darkow, N.; Cain, S ; Krause, S.; Reimer, T.; Rauh, C. ; Stefaniak, D.; Beerhorst, M.; Thiele, T.; Briese, L.E.; Schnepfer, K.; Riccius, J.: Focused research on RLV-technologies: the DLR project AKIRA, 8th EUROPEAN CONFERENCE FOR AERONAUTICS AND SPACE SCIENCES (EUCASS), Madrid July 2019
12. Cain, S., Krause, S., Binger, J.: Entwicklung einer automatischen Koppereinheit für das Einfangen einer wiederverwendbaren Trägerstufe im In-Air-Capturing, DLRK, München, 2017 http://elib.dlr.de/114085/1/DLRK_Paper_Cain_Final.pdf
13. Cain, S., Krause, S., Binger, J.: First development steps of an actively controlled drogue, ICUAS 2018, 12.-15. July 2018, Dallas, USA
14. Bussler, L.; Wilken, J.; Stappert, S.; Sippel, M.; Dietlein, I.; Dumont, E.: Assessment of VTVL and VTHL Reusable First Stages, HiSST 2018-1130816, 1st HiSST: International Conference on High-Speed Vehicle Science Technology, Moscow, November 2018
15. N.N.: A Structured Approach to RLV Technology Flight Testing, NASA, September 2002
16. Sippel, M.; Bussler, L.; Krause, S.; Cain, S.; Stappert, S.: Bringing Highly Efficient RLV-Return Mode "In-Air-Capturing" to Reality, HiSST 2018-1580867, 1st HiSST: International Conference on High-Speed Vehicle Science Technology, Moscow, November 2018, <https://elib.dlr.de/125921/1/HiSST18-4.pdf>
17. Calabuig, G.J.D.: Conceptual Cost Estimation for Recovery and Refurbishment Operations of Reusable Launch Vehicles, DLR internal report, SART TN-006/2019, 2019.
18. Stappert, S.; Wilken, J.; Bussler, L.; Sippel, M.: A Systematic Comparison of Reusable First Stage Return Options, 8th EUROPEAN CONFERENCE FOR AERONAUTICS AND SPACE SCIENCES (EUCASS), Madrid 2019