

Phase estimation for navigation purpose in maritime environments

1st Lars Grundhöfer
 German Aerospace Center
 Neustrelitz, Germany
 lars.grundhoefer@dlr.de

2nd Stefan Gewies
 German Aerospace Center
 Neustrelitz, Germany
 stefan.gewies@dlr.de

Abstract—Trading in the modern world strongly depends on merchant shipping. Here, Global Navigation Satellite Systems (GNSS) are used for Positioning, Navigation and Timing (PNT) information. Because of the importance of this information the maritime community searches for a terrestrial backup system using signals-of-opportunity. This paper describes phase estimation of these signals, as a first step towards reliable PNT information. Furthermore, introduced models and techniques could support time synchronization of none maritime applications.

I. INTRODUCTION

The ongoing globalization is accompanied with increasing vessel sizes and traffic density in ecological and economical sensitive areas. To prevent collisions and groundings Global Navigation Satellite Systems (GNSS) are used today as the primary source for Positioning, Navigation and Timing (PNT) information. Because of GNSS vulnerability the maritime world is looking for a backup system. R(anging)-Mode, a new system which utilizes existing maritime signals-of-opportunity is one candidate to provide absolute positioning and timing. Under discussion are the signals of the Automatic Identification System (AIS) and the maritime radio beacon. Currently a R-Mode reference implementation on maritime radio beacons broadcasts R-Mode test signals in the 300 kHz band. Here, the legacy signal, with Minimum Shift Keying (MSK) modulated information, is extended by two continuous wave (CW) signals [1].

The paper shows how the phase of these three signal components is estimated using measurements of a Software Defined Radio (SDR) with external time synchronization. At first the used signal model is shown. After that a maximum likelihood estimator of the phase and a Hilbert transform based estimator are introduced. Furthermore, the measurement setup is described, with special attention given to time synchronization, using a GNSS stabilized rubidium clock, which is a key factor for good estimation results. In the end the outcome is presented when applying these methods on recorded signals from German radio beacons located in Helgoland and Zeven.

II. SIGNAL MODEL

The MSK modulated radio beacon signal of the radio beacon $s_{\text{msk}}(t)$ can be described as

$$s_{\text{msk}}(t) = b_{\text{msk}} \cos \left(2\pi f_c t + b_k(t) \frac{\pi t}{2T} + \theta_k \right) \quad (1)$$

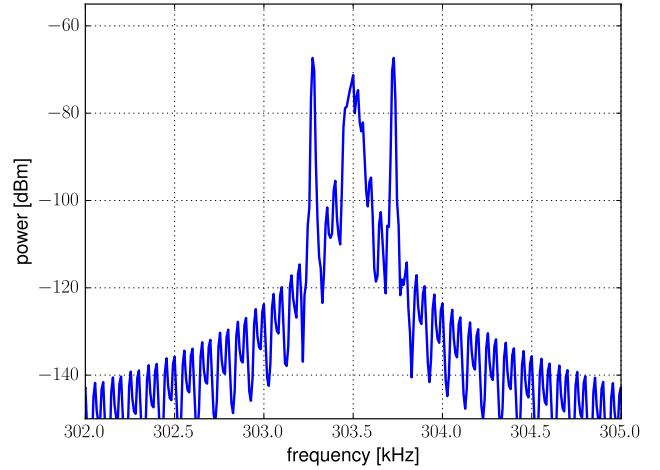

Fig. 1. Simulated spectrum of R-Mode signal

during modulation of the k^{th} bit with

$$b_k(t) = -a_I(t)a_Q(t) \quad (2)$$

where b_{msk} describes the amplitude, f_c represents the carrier frequency, T is the time for modulation of one bit, a_I and a_Q are the inphase and quadrature data bits. θ_k is the superposition of a phase offset which belongs to the already sent data known as memory of the MSK and a distance dependent unknown phase shift [2]. The unknown phase shift has to be estimated for a distance estimation.

To overcome the ambiguities caused by the wavelength, which is 1 km for the frequency band of the beacon, it was suggested to introduce two continuous waves (CW) signals [1], with a displacement of ± 225 Hz to the carrier. The frequencies are chosen for low interference, as the MSK modulation used for the legacy signal has roots at this frequencies in the spectrum. Using the continues signals parts s_{cw1} and s_{cw2} , a term with frequency $f_{\text{beat}} = 450$ Hz is derived. This is called beat frequency, with ambiguities every 666 km in the phase. The CW signals s_{cw1} and s_{cw2} can be described as

$$s_{\text{cw1}}(t) = b_{\text{cw1}} \sin(2\pi(f_c - 225 \text{ Hz})t + \theta_{\text{cw1}}) \quad (3)$$

and

$$s_{cw2}(t) = b_{cw2} \sin(2\pi(f_c + 225 \text{ Hz})t + \theta_{cw2}) \quad (4)$$

where θ_{cw1} and θ_{cw2} are unknown distance dependent phase shifts, which should be zero on the transmitter site. So the overall signal can be described by superposition of (1), (3) and (4).

$$s(t) = s_{msk}(t) + s_{cw1}(t) + s_{cw2}(t) \quad (5)$$

$$\begin{aligned} &= b_{msk} \cos\left(2\pi f_c t + b_k(t) \frac{\pi t}{2T} + \theta_k\right) \\ &+ b_{cw1} \sin(2\pi(f_c - 225 \text{ Hz})t + \theta_{cw1}) \\ &+ b_{cw2} \sin(2\pi(f_c + 225 \text{ Hz})t + \theta_{cw2}) \end{aligned} \quad (6)$$

Fig. 1 shows the spectrum of a simulated signal with a carrier frequency 303.5 kHz. The three components are well distinct.

III. ESTIMATION

Because it is not suitable to divide the components of the signal by filtering, the model parameter should be estimated. It is supposed that the angular frequency $\omega_c = 2\pi f_c$ is known. So only the phase offsets θ_{msk} , θ_{cw1} , θ_{cw2} and the amplitude b_{msk} , b_{cw1} , b_{cw2} have to be estimated, to reconstruct the entire R-Mode signal.

A. Maximum likelihood approach

For estimation of the CW parameters we can use a maximum likelihood approach, with the unknown parameter vector $\alpha_i = [\omega_i, b_i, \theta_i]^T$ described by Rife and Boorstyn [3]. The sample vectors Z is defined as $Z = X + jY$, where X represents the real sampled signal and Y is the Hilbert transform of X . So the joint probability function $f(Z, \alpha_i)$ is

$$f(Z, \alpha_i) = \left(\frac{1}{\sigma^2 2\pi}\right) \exp\left[-\frac{1}{2\sigma^2} \sum_{n=0}^{N-1} ((X_n - \mu_n)^2 + (Y_n - \nu_n)^2)\right] \quad (7)$$

with

$$\mu_n = b_i \cos(\omega_i t_n + \theta_i) \quad (8)$$

$$\nu_n = b_i \sin(\omega_i t_n + \theta_i) \quad (9)$$

with σ as variance. From equation (7) an almost maximum likelihood function can be derived for a number of d CW signals:

$$L = \sum_{i=1}^d \{2b_i \text{Re}[e^{j\theta_i} A(\omega_i)] - b_i^2\} \quad (10)$$

where

$$A(\omega_i) = \frac{1}{N} \sum_{n=0}^{N-1} (X_n - jY_n) e^{-jn\omega T} \quad (11)$$

for N equidistant samples. This is called almost maximum likelihood function, because a cross correlation term is neglected. This is suitable for a good signal-to-noise ratio and

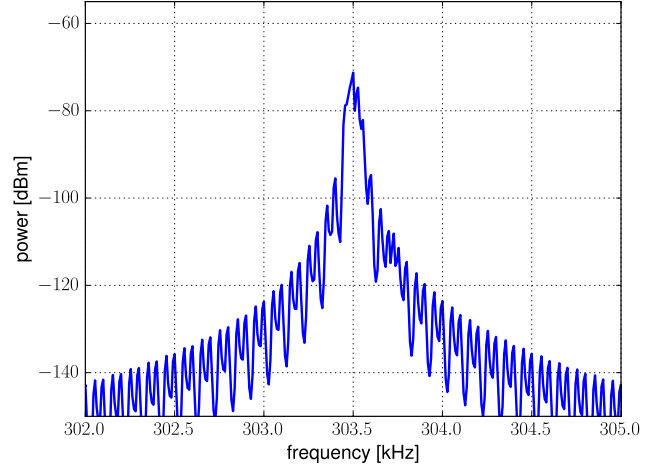

Fig. 2. Simulated spectrum of R-Mode signal with subtracted CW signals

equal amplitudes b_i . This function can be easily maximized for known ω_i by

$$\tilde{b}_i = |A(\omega_i)| \quad (12)$$

$$\tilde{\theta}_i = \arg[A(\omega_i)] \quad (13)$$

Using the known frequencies $\omega_{cw1} = 2\pi(f_c + 225 \text{ Hz})$ and $\omega_{cw2} = 2\pi(f_c - 225 \text{ Hz})$, θ_{cw1} , θ_{cw2} and the amplitude b_{cw1} , b_{cw2} can be estimated.

In Fig. 2 the spectrum of the R-Mode signal is shown after CW signals estimated from (12) and (13) are subtracted from the simulated sampled signal. Compared to Fig. 1 the peaks beside the MSK signal completely vanished which confirms the outlined approach.

B. Hilbert transform approach

In the next step the parameters of the MSK signal have to be estimated. As there exist no known maximum likelihood

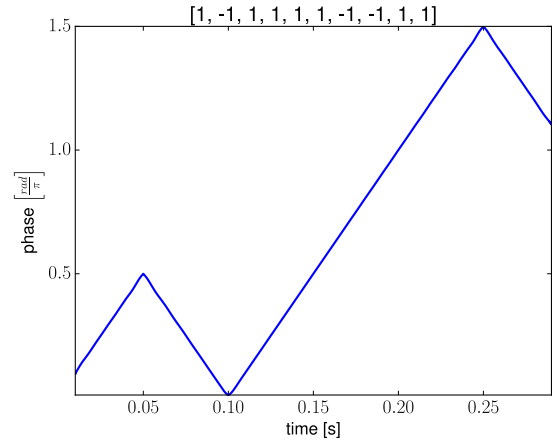

Fig. 3. Phase shift between modulated and carrier signal for a MSK signal

estimation of the phase θ_{msk} [1], it is suggested to use the Hilbert transform

$$\hat{X} = -j X(j\omega_c) \text{sgn}(\omega_c) \quad (14)$$

It transforms the real valued sampled signal X into a so called analytical signal \hat{X} , which is complex. Assuming that X contains only the sampled MSK signal, then the phase of the MSK signal is the phase of \hat{X} . Fig. 3 shows the results when the estimated CW signals are subtracted from the R-Mode signal, a Hilbert transform is applied and in the end the ongoing phase $\omega_c t$ is subtracted. The figure clearly shows the $\frac{\pi}{2}$ phase shift of the modulation, so it is possible to decode the simulated bit stream. A generic MSK signal with zero phase offset is generated based on the bit pattern, and the phase of sampled and generic samples is compared, in order to get a distance estimation.

IV. SOFTWARE DEFINED RADIO BASED RECEIVER

In the previous parts of the paper, the theory of phase estimation was shown with a purely software simulated R-Mode signal. The next part introduces a software defined radio receiver for the R-Mode signal. Fig. 4 shows the block diagram of our test setup. The main part is the Ettus N210 SDR with a LFRX daughterboard [4]. As a receiving antenna a custom made loop antenna with a two stage lossless feedback amplifier is used. For now an external time synchronization is needed, given that only two stations transmit a R-Mode signal. So a positioning and timing solution is not possible with the current constellation. As a timing reference the GNSS stabilized rubidium frequency standard LL-3760 of Lange Electronic [5] is used. The time of the SDR, is synchronized by a pulse per second (PPS) signal. For the phase synchronization a 10 MHz reference signal is used.

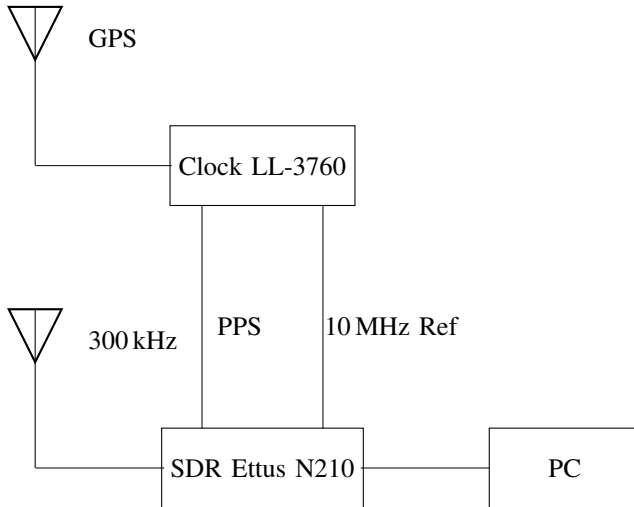

Fig. 4. Software defined radio block diagram

The SDR is connected to the PC over ethernet. The PC configures the SDR and stores the sampled data. Fig. 5 shows the received spectrum calculated in post processing

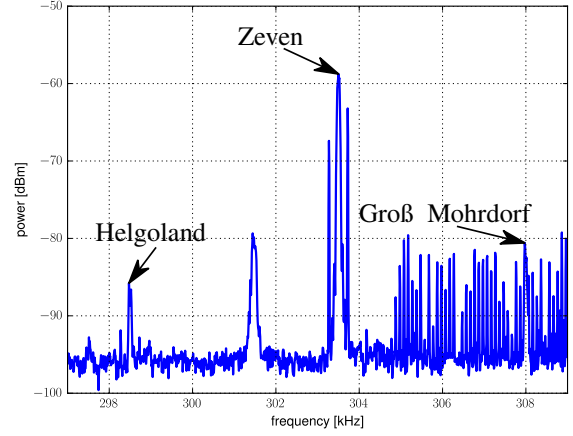

Fig. 5. Received spectrum with SDR

for a real measurement taken at the Elbe near Stade. The strongest signal is the maritime radio beacon station Zeven at 303.5 kHz which clearly transmits the R-Mode signal. The R-Mode enabled transmitter Helgoland is shown at 298.5 kHz. The station Groß Mohrdorf can not be seen due to noise, which appears above 305 kHz. This noise is characteristic for nearby solar cells. Another disturbance appears at 301.5 kHz as an unknown signal. Besides calculating the spectrum, it was also possible to demodulate and decode the messages of the station Zeven and Helgoland.

V. POST PROCESSING

Fig. 5 shows that the receiver got a clear R-Mode signal from Zeven. The post processing workflow to estimate the phase starts by applying a digital filter with a bandwidth of 500 Hz around the carrier frequency. In the next step (12) and (13) are used to estimate the unknown parameters of the CW signals.

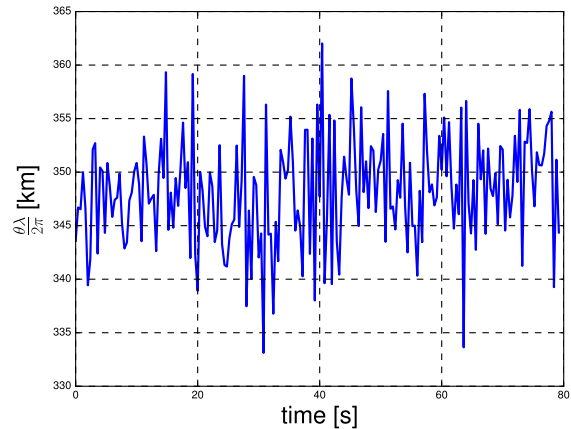

Fig. 6. Distance derived from phase estimation of beat frequency

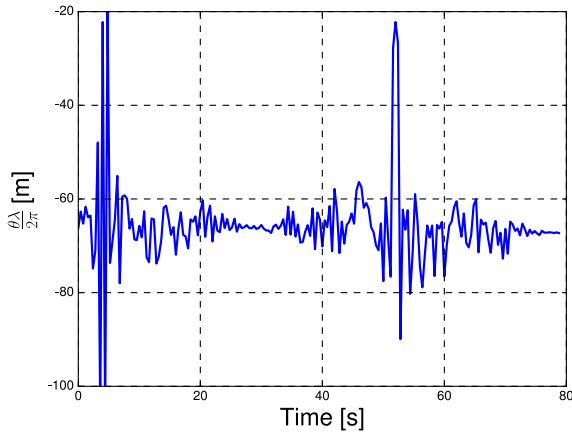

Fig. 7. Distance derived from phase estimation of MSK signal part

The calculated distance based on the estimated phase of the beat frequency for the real measurement is shown in Fig. 6. It shows a standard deviation of about 8 km. Due to large outliers the peak to peak value is around 35 km. Additionally the estimation seems to have cyclic signal disturbances every 90 s which is not shown. A generic signal with the two CW based on the estimated parameter is subtracted from the received samples. After the CW signals are canceled out the Hilbert transform is applied and the phase is estimated as described in section III-B. Fig. 7 shows the estimated phase offset derived by the MSK component with respect to the ambiguities, which occur every 250 m due to the memory of the MSK. Huge cyclic outliers are clearly seen every 50 s. The reason for the cyclic disturbances shown in Fig. 6 and Fig. 7 are unknown and subject of further investigations.

VI. CONCLUSION

The paper shortly introduces a maritime backup system for timing and positioning information called R-mode. R-Mode utilizes different signals of opportunities. In this introduction the focus is on using maritime radio beacon signals with added CW components. A signal model is suggested and a maximum likelihood approach for estimating the parameters of the CW is described. Additionally a way to estimate the phase of the MSK signal with the Hilbert transform is presented. The complete workflow is verified with simulations. Furthermore a SDR based receiver is introduced and real measurements are processed the same way as the simulated data. The results show that in real measurements cyclic disturbances occur. Another huge challenge is to become independent of an external timing source. Here a time different of arrival method might be possible. Nevertheless, the methods are convenient for estimating the phase of our signal model. With more investigation on the interference it should be possible to get even better information about timing and position.

REFERENCES

- [1] D. P. S. Dr. Gregory Johnson, "Feasibility study of R-mode using MF DGPS transmissions," ACCSEAS, Tech. Rep., 2014.

- [2] S. Pasupathy, "Minimum shift keying: A spectrally efficient modulation," *IEEE Communications Magazine*, vol. 17, no. 4, pp. 14–22, July 1979.
- [3] D. C. Rife and R. R. Boorstyn, "Multiple tone parameter estimation from discrete-time observations," *The Bell System Technical Journal*, vol. 55, no. 9, pp. 1389–1410, Nov 1976.
- [4] Ettus Research, "USRP N200/N210 networked series-datasheet," Sep. 2012.
- [5] Lange-Electronic GmbH, "LL-3760 GPS timing receiver," Tech. Rep., 2015.