

Robust Two Degree of Freedom Vehicle Steering Controller Design

Bilin Aksun Güvenç^{*}, Tilman Bünte[#], Dirk Odenthal[#] and Levent Güvenç^{*,1}

^{*}Department of Mechanical Engineering, İstanbul Technical University
Gümüşsuyu, Taksim, İstanbul TR-80191, Turkey, bilin@mkn.itu.edu.tr

[#]Robust Control Group, Institute of Robotics and Mechatronics, DLR
German Aerospace Center, Oberpfaffenhofen, Postfach 1116, D-82230 Wessling, Germany

Abstract

Robust steering control based on a specific two degree of freedom control structure is used here for improving the yaw dynamics of a passenger car. The usage of an auxiliary steering actuation system for imparting the corrective action of the steering controller is assumed. The design study is based on six operating conditions for vehicle speed and the coefficient of friction between the tires and the road representing the boundary of the operating domain of the vehicle. The design is carried out by finding the region in controller parameter plane where Hurwitz stability and a mixed sensitivity frequency domain constraint are simultaneously satisfied. A velocity based gain scheduling type implementation is used. Moreover, the steering controller has a fading effect that leaves the low frequency driving task to the driver, intervening only when necessary. The effectiveness of the final design is demonstrated using linear and nonlinear simulations.

1. Introduction

Dangerous yaw motions of an automobile may result from unexpected yaw disturbances caused by unsymmetrical car dynamics perturbations like side wind forces, unilateral loss of tire pressure or braking on unilaterally icy road (μ -split braking). Safe driving requires the driver to react extremely quickly in such dangerous situations. This is not possible as the driver who can be modeled as a high gain control system with dead time overreacts, resulting in instability. Consequently, improvement of automobile yaw dynamics by active control to avoid such catastrophic situations has been and is continuing to be a subject of active research. One approach for yaw dynamics improvement is to use individual wheel braking, thereby creating the moment that is necessary to counteract the undesired yaw motion (van Zanten, 1995). An alternative approach that is used in this work is to command additional steering angles to create the counteracting moment (Ackermann et al, 1996). This latter approach has the advantage of having a larger lever arm with the associated capability of generating the required moments by using only small steering wheel corrective actions. As opposed to individual wheel braking, steering control can be applied continuously, also aiming at the compensation of small errors. The biggest advantage, obviously, can be achieved by making use of both active steering and individual wheel braking control.

There are basically two different possibilities of using the front wheel steering angle as control input. The first possibility is to add, in the electronic control unit, the steering controller output (*auxiliary steering angle*) to the steering signal which comes from

the driver. In this case, the total front wheel steering angle is set by a steer-by-wire actuator. Here, the second possibility, where the auxiliary steering angle is added mechanically, is employed. Therefore, an *auxiliary steering actuator* is required and the range of the auxiliary steering angle will consequently be limited. This causes the risk of actuator saturation in the presence of model errors or disturbances. Therefore, the control action should fade out after its initial corrective action instead of winding up so that the auxiliary steering angle will be fully available for new control action.

There are several physically motivated constraints imposed on the steering controller. It should be robust with respect to large variations in longitudinal speed, payload and road adhesion. Moreover, its actions should not be uncomfortable for the driver and passengers. The corrective actions should be imparted only when necessary i.e. in the frequency range where the driver is overstrained with the fast rejection of disturbances. In addition, the corrective action from the steering controller should not saturate the steering actuator as this can lead to limit cycle oscillations (Ackermann and Bünte, 1999). In this paper, a two degree of freedom steering controller architecture based on the disturbance observer method (Ohnishi, 1987; Umeno and Hori, 1991; Güvenç and Srinivasan, 1994) is adapted to the vehicle yaw dynamics problem and shown to robustly improve vehicle yaw dynamics performance. Thereby, the parameter space approach (Ackermann et al, 1993) is applied to incorporate eigenvalue and bode magnitude sensitivity specifications (Odenthal and Blue, 2000) into the controller design. The same two degree of freedom steering controller structure was successfully applied to automobile yaw dynamics improvement in the previous studies of Bünte et al (2001) and Aksun Güvenç et al (2001). In contrast to the abovementioned references, an auxiliary steering actuation system, a steering controller that only intervenes when necessary and a velocity gain scheduled implementation that is tested throughout the range of operation are considered and treated here.

The organization of the paper is as follows. The linearized single track vehicle yaw dynamics model being used for control design and analysis is introduced in Section 2 along with the numerical data being used. The steering controller design specifications are presented in Section 3. The two degree of freedom steering control architecture being used is presented in Section 4. Design satisfying a mixed sensitivity frequency domain bound is carried out in controller parameter space in Chapter 5. Linear and nonlinear simulation results are also given in this section to demonstrate the effectiveness of the proposed approach. The paper ends with a summary of the main results in Section 6.

¹ acknowledges support of the Alexander von Humboldt Foundation

2. Vehicle Model And Numerical Data

The car model which is used for the investigations in this paper is the classical linearized single track model shown in Figure 1. Its major variables and geometric parameters are

$F_f(F_r)$: Lateral wheel force at front (rear) wheel
r	: Yaw rate
β	: Chassis side slip angle at center of gravity (CG)
v	: Magnitude of velocity vector at CG ($v > 0, dv/dt = 0$)
$l_f(l_r)$: Distance from front (rear) axle to CG
δ_f	: Front wheel steering angle
m	: Vehicle mass
J	: Moment of inertia w.r.t. a vertical axis through the CG

For small steering angle δ_f and small side slip angle β , the linearized equations of motion are (see Ackermann et al, 1993)

$$\begin{bmatrix} mv(d\beta/dt + r) \\ ml_f l_r dr/dt \end{bmatrix} = \begin{bmatrix} F_f + F_r \\ F_f l_f - F_r l_r \end{bmatrix} \quad (1)$$

The tire force characteristics are linearized as

$$F_f(\alpha_f) = \mu c_{f0} \alpha_f, \quad F_r(\alpha_r) = \mu c_{r0} \alpha_r \quad (2)$$

where c_{f0}, c_{r0} are the nominal tire cornering stiffnesses at $\mu=1$, μ is the road adhesion factor and α_f and α_r are the tire side slip angles given by

$$\alpha_f = \delta_f - \left(\beta + \frac{l_f}{v} r \right) \quad (3)$$

$$\alpha_r = - \left(\beta - \frac{l_r}{v} r \right) \quad (4)$$

The transfer function from the front wheel steering angle δ_f to the yaw rate r can be computed from (1)-(4) as

$$G(s) = \frac{r(s)}{\delta_f(s)} = \frac{b_0 + b_1 s}{a_0 + a_1 s + a_2 s^2} \quad (5)$$

with

$$\begin{aligned} b_0 &= c_f c_r (l_f + l_r) v \\ b_1 &= c_f l_f m v^2 \\ a_0 &= c_f c_r (l_f + l_r)^2 + (c_r l_r - c_f l_f) m v^2 \\ a_1 &= (c_f (J + l_f^2 m) + c_r (J + l_r^2 m)) v \\ a_2 &= J m v^2 \end{aligned}$$

The steady state gain of the nominal single track model is

$$K_n(v) = \lim_{s \rightarrow 0} G(s) \Big|_{\mu=1} \quad (6)$$

at the chosen longitudinal speed v and at nominal friction coefficient which is taken as $\mu = 1$ for dry road conditions here.

The vehicle model data used here corresponds to a mid-sized passenger car. The nominal values of the variables in the linearized single track model are $l_f=1.25$ m, $l_r=1.32$ m, $m=1296$ kg, $J=1750$ kgm², $c_{f0}=84243$ N/rad and $c_{r0}=95707$ N/rad. Uncertainty in these parameters enters the design process in this paper indirectly through the weight for complementary sensitivity.

3. Design Specifications

The variable that exhibits the largest variation during operation is the vehicle longitudinal speed v . The mass m of the vehicle and the tire cornering stiffnesses c_f and c_r can also exhibit large variations, the latter two being due to variations in friction coefficient μ between the road and the tires. This effect is captured in the formulation of the previous section in the new variables $\tilde{m} = m/\mu$ and $\tilde{J} = J/\mu$, called virtual mass and virtual moment of inertia, respectively. The additional uncertainty in the cornering stiffnesses due to uncertain parameters like normal force, longitudinal acceleration, tire pressure and temperature are captured in uncertainty in c_{f0} and c_{r0} here. In addition to the vehicle yaw dynamics, the dynamics of the auxiliary steering actuator that is used to transmit the auxiliary steering angle is also being considered in analysis and design.

The longitudinal velocity v is treated as a varying parameter here rather than an uncertain one as it can be easily measured and used for gain scheduling. It is assumed to vary between a minimum value of 10 m/s and a maximum value of 50 m/s during operation. The steering controller is assumed to be softly shut off at speeds below 10 m/s since the driver is easily capable of rejecting yaw disturbances at these speeds without the need for an additional steering input. The maximum value of the friction coefficient μ is assumed to be one (dry road) while its minimum value is assumed to vary between 0.2 (icy road) at low speeds and 0.8 (wet road) at high speeds as seen in Figure 2.

The six operating conditions considered in design are all at the boundary of the operating domain and are marked with crosses in Figure 2. The aim in steering controller design is to make sure that stable operation and then improved yaw dynamics are achieved for all six operating conditions (assuming that similar results will then hold within the whole operating domain as well) and all possible values of the other uncertain parameters. The improved yaw dynamics corresponds to good disturbance rejection properties where the possible disturbances include the effect of side wind forces and μ -split braking. A novel, disturbance observer based steering controller is designed and shown to effectively achieve the desired aims in this paper. This steering controller has a low frequency fading effect (a control feature previously applied to a different steering controller structure and published in Ackermann and Bunte, 1997), leaving the low frequency, non-critical steering tasks to the driver and intervening only in the frequency range where the driver's reaction time is insufficient.

4. Two Degree Of Freedom Steering Control

The disturbance observer is a specific method of designing a two degree of freedom control architecture to achieve insensitivity to modeling error and disturbance rejection (Ohnishi, 1987; Umeno and Hori, 1991; Güvenç and Srinivasan, 1994). Its implementation for vehicle yaw dynamics improvement where an auxiliary steering actuator is used is displayed in Fig. 3. Referring to this figure, $G=G_n(1+A_m)$ is the single track yaw dynamics model with multiplicative uncertainty A_m , G_n is the nominal model or a desired vehicle yaw dynamics model to be followed and G_a is the auxiliary steering actuator model. r is the vehicle yaw rate and δ_s and δ_c are the steering commands coming from the driver via the steering wheel and the auxiliary steering angle coming from the steering controller, respectively. G_d is the transfer function from yaw disturbance torque M_d to yaw rate. Disturbance observer design requirements are specified in terms of the unity gain low pass filter Q which should be small at high frequencies for sensor noise attenuation and robustness of stability in the presence of high frequency unmodelled dynamics. At low frequencies, Q is usually chosen as unity for good steady state accuracy, disturbance rejection and model regulation. Then, due to the specific controller structure, the input-output behavior of the controlled system including its steady state behavior will be the same as that of the nominal (or desired) model G_n up to the bandwidth of the low pass filter Q . The low frequency design requirements are, however, remarkably different in the vehicle steering control application considered here where the driving task should be left to the driver at low frequencies (i.e. the fading effect). The result is that, contrary to standard disturbance observer design practice, a band-pass Q filter has to be designed as is illustrated in Fig. 4 where the other design specifications have also been summarized. The disturbance observer, then, acts only within its band-pass region to improve vehicle yaw dynamics.

A similar vehicle steering control architecture was applied in two previous studies (Bünte et al, 2001; Aksun Güvenç et al, 2001) to the steer-by-wire type implementation. Γ -stability and weighted sensitivity type constraints were evaluated in controller parameter space to obtain a design which robustly satisfied the design objectives in Bünte et al (2001). A mixed sensitivity type robust performance criterion was used for the design in Aksun Güvenç et al (2001). In contrast, this paper uses an auxiliary steering controller instead of a steer-by-wire implementation and also includes the fading effect to avoid auxiliary steering actuator saturation.

5. Parameter Space Design And Simulations

The Q filter is chosen to be the simplest band pass filter of the form

$$Q(s) = \frac{\tau_{bp}s}{(\tau_{bp}s+1)(\tau_Qs+1)} \quad (7)$$

The pass band of $Q(s)$ in (7) is between the frequencies $1/\tau_{bp}$ and $1/\tau_Q$ in Hz. τ_{bp} is chosen here as 0.25 sec. The desired yaw dynamics model is chosen as a first order system here given by

$$G_n(s) = \frac{K_n(v)}{\tau_n s + 1} \quad (8)$$

where $K_n(v)$ is gain scheduled according to (6). Note that the time constant τ_n can also be gain scheduled or that the nominal yaw dynamics model at the chosen velocity can also be used as the desired model. The actuator used is modeled as the second order system

$$G_a(s) = \frac{(10 \cdot 2\pi)^2}{s^2 + 2 \cdot 0.7 \cdot (10 \cdot 2\pi)s + (10 \cdot 2\pi)^2} \quad (9)$$

The two free controller parameters τ_n and τ_Q are tuned in the design effort to meet the mixed sensitivity requirement

$$|W_S S| + |W_T T| < 1 \text{ for } \forall \omega \quad (10)$$

The sensitivity function weight W_S and the complementary sensitivity function weight W_T that were used in design are

$$W_S(s) = \frac{0.3333s + 4.2}{1.8s + 1.26} \quad (11)$$

$$W_T(\omega) = \max \left\{ \left| \frac{1.667s + 6.2833}{s + 188.5} \right|_{s=j\omega}, \left| \frac{0.04268s^2 + 1.8977s + 0.90719}{s^2 + 9.006s + 17.6494} \right|_{s=j\omega} \right\} \quad (12)$$

The complementary sensitivity weight in (12) is designed to penalize parametric uncertainty at low frequencies and unmodeled dynamics uncertainty at high frequencies.

The design approach is based on mapping the frequency domain constraint (10) with weights given in (11) and (12) into the plane of controller parameters τ_n and τ_Q . More detailed information on the solution procedure used can be found in several references (Odenthal and Blue, 2000; Güvenç and Ackermann; Aksun Güvenç et al, 2001). This procedure is repeated for all six of the marked operating conditions in Figure 2. The final solution region obtained by intersection in controller parameter plane of all regions and the region for Hurwitz stability is shown in Figure 5. The final design point satisfying (10) for all six operating conditions is chosen as $\tau_n=0.12$ sec and $\tau_Q=0.02$ sec and is marked with a cross in the enlarged plot of Figure 6.

A linear simulation study is performed next to assess the time domain performance that is achieved. Steering wheel and yaw moment disturbance step inputs are the two simulation maneuvers that were investigated. The steering wheel step input is normalized by the gain $K_n(v)$ for dry road ($\mu=1$) in the simulations for easier comparison of the results. The linear simulation results shown in Figures 7 and 8 demonstrate the achievement of good steering command tracking and excellent disturbance rejection at all six operating points. The conventional car responses are displayed with dashed lines whereas the corresponding steering controlled car responses are displayed as solid lines. Note from Fig. 8 that the steering controller works mainly during the first 0.25 sec following the disturbance. The disturbance rejection task is then gradually handed over to the driver. The controlled disturbance rejection up to an assumed driver reaction time of 0.5 sec is seen to be superior to that of the conventional car. The gradual change in yaw rate after the 0.5 sec can easily be handled by the driver. Note that the timing of when the driver takes over can easily be adjusted by changing the parameter τ_{bp} in (7).

A realistic, nonlinear, higher order model that models the actual dynamics of the vehicle quite accurately is used to test the gain scheduling type of implementation. A commercially available program (Anon., 2000) that is also used by automotive companies in hardware in the loop simulation and rapid controller prototyping was chosen for this purpose. This program has a quite realistic model of a vehicle including tire, drive train, engine, suspension and transmission dynamics and coupling between its various subsystems. A μ -split maneuver during which the tires enter an ice patch on one side while the tires on the other side are on dry road was selected for the simulation. This is a very demanding maneuver in which the conventional (uncontrolled) vehicle becomes unstable and does almost a complete turn (see top of Fig. 9). In contrast, the steering controller of this paper works very well by keeping the undesired yaw rotation to a very low level during this μ -split maneuver as is seen in the bottom plot of Figure 9. This result shows that the steering controller of this paper works quite satisfactorily in realistic situations also.

6. Summary

A two degree of freedom auxiliary steering controller based on the disturbance observer was used here for vehicle yaw dynamics improvement. Steering controller design was carried out in controller parameter space to satisfy a mixed sensitivity frequency domain bound, thus solving a robust performance problem. Quite untypical of disturbance observer design, a band pass Q filter was used here to achieve the desired fading action. In this manner, the steering controller only intervened during the panic reaction time of the driver, leaving the driving task gradually back to the driver afterwards. Linear simulation results were used to demonstrate the effectiveness of the method. Demonstration of the improved performance by a more realistic, nonlinear simulation maneuver with a velocity based gain scheduling formulation for operating the control smoothly with changing speed was also presented.

REFERENCES

- Ackermann, J. and Bünte, T., 1999, "Robust prevention of limit cycles for robustly decoupled car steering dynamics," *Kybernetika*, vol. 35, no. 1, pp. 105-116.
- Ackermann J. and Bünte, T., 1997, "Automatic car steering control bridges over the driver reaction time", *Kybernetika*, vol. 33, no. 1, pp. 61-74.
- Ackermann, J., Bünte, T., Siemel, W., Jeebe, H. and Naab, K., 1996, "Driving safety by robust steering control," *Proc. of the Int. Symposium on Advanced Vehicle Control and Safety*, Aachen, Germany.
- Ackermann, J., Bartlett, A., Kaesbauer, D., Siemel, W. and Steinhäuser, R., 1993 *Robust control: Systems with uncertain physical parameters*, Springer, London.
- Aksun Güvenç, B., Güvenç, L., Odenthal, D. and Bünte, T., 2001, "Robust two degree of freedom vehicle steering control satisfying mixed sensitivity constraint," *European Control Conference*, submitted.
- Anonymous, 2000. *VEDYNA User Guide*, TESIS Dynaware GmbH, Munich.
- Bünte, T., Odenthal, D., Aksun Güvenç, B., Güvenç, L., 2001, "robust vehicle steering control based on the disturbance observer," *IFAC Workshop on Advances in Automotive Control*.
- Güvenç, L. and Srinivasan, K., 1994, "Friction compensation and evaluation for a force control application," *J. of Mechanical Systems and Signal Processing*, vol. 8, no. 6, pp. 623-638.

Güvenç, L., Ackermann, J., "Links between the parameter space and frequency domain methods of robust control," *International Journal of Robust and Nonlinear Control*, Special Issue on Robustness Analysis and Design for Systems with Real Parametric Uncertainties, submitted.

Odenhal, D. and Blue, P., 2000, "Mapping of frequency response magnitude performance specifications into parameter space," *Proc. of the 3rd IFAC Symposium on Robust Control Design*, Prague.

Ohnishi, K., 1987, "A new servo method in mechatronics," *Trans. Japanese Soc. Elect. Eng.*, vol. 107-D, pp. 83-86.

Umeno, T. and Hori, Y., 1991, "Robust speed control of dc servomotors using modern two degrees-of-freedom controller design," *IEEE Transactions on Industrial Electronics*, vol 38, no. 5, pp. 363-368.

van Zanten, A.T., Erhardt, R. and Pfaff, G., 1995, "VDC, the vehicle dynamics control system of Bosch," SAE paper No. 950759.

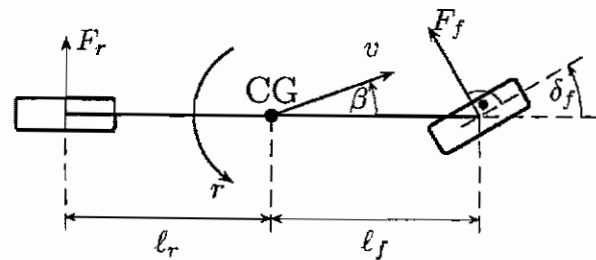

Figure 1 Single track model for car steering.

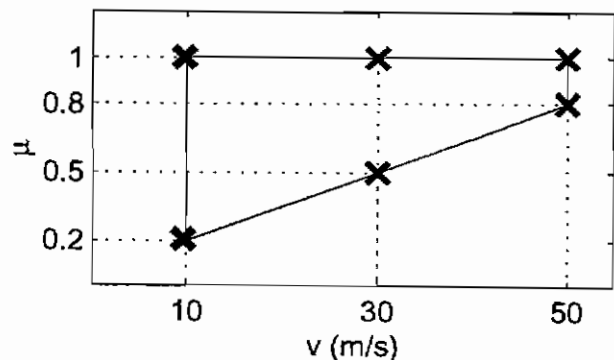

Figure 2 Operating domain

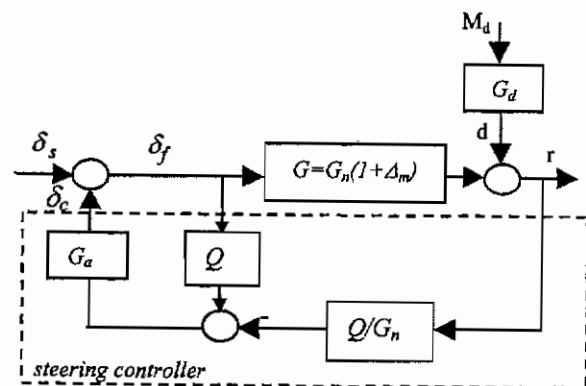

Figure 3 Two degree of freedom steering controller

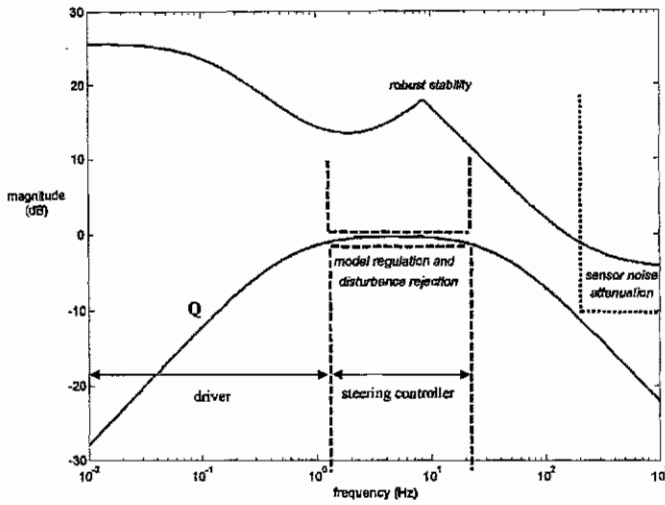

Figure 4 Q filter design specifications

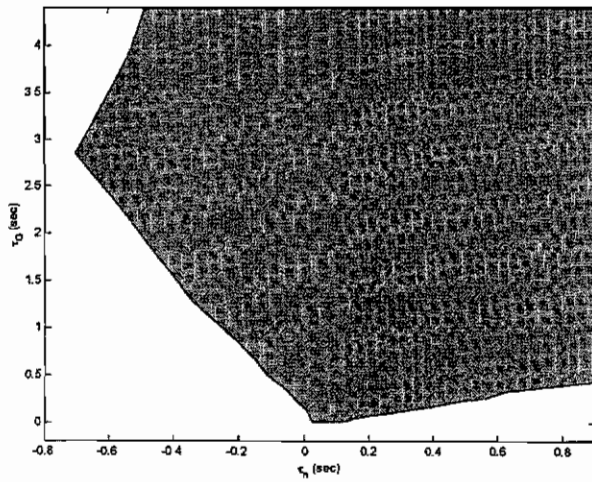

Figure 5 Solution region satisfying constraints at all six operating points

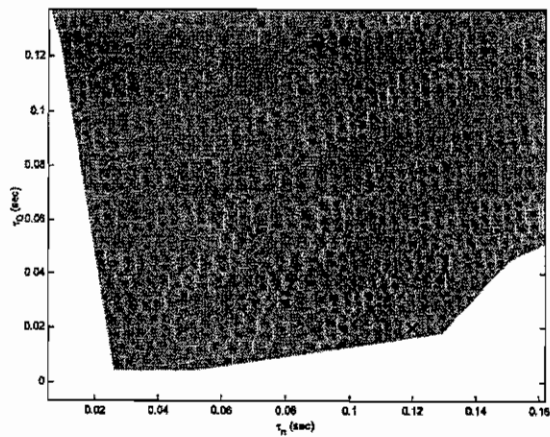

Figure 6 Solution region satisfying constraints at all six operating points -- enlarged view

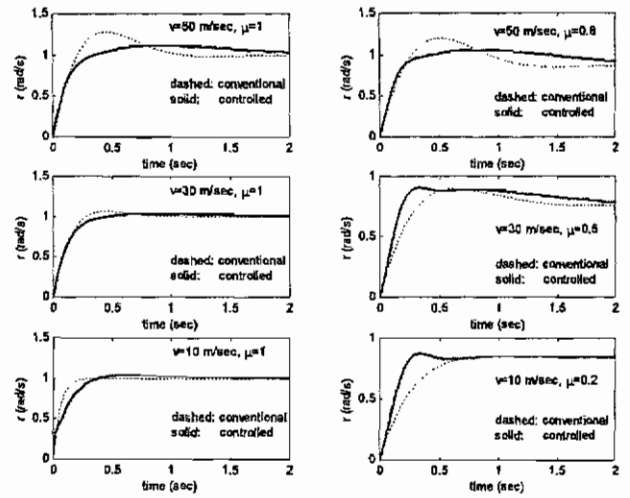

Figure 7 Steering wheel step input responses

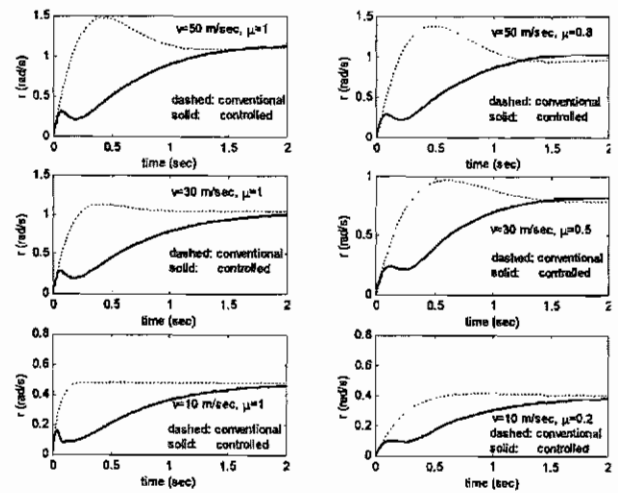

Figure 8 Yaw moment disturbance step responses

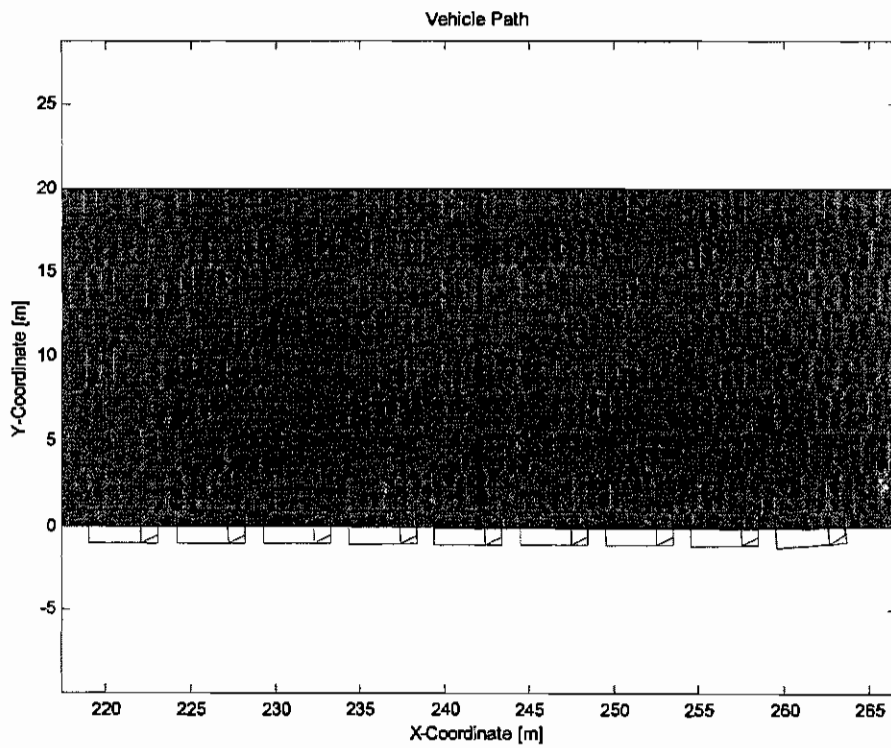
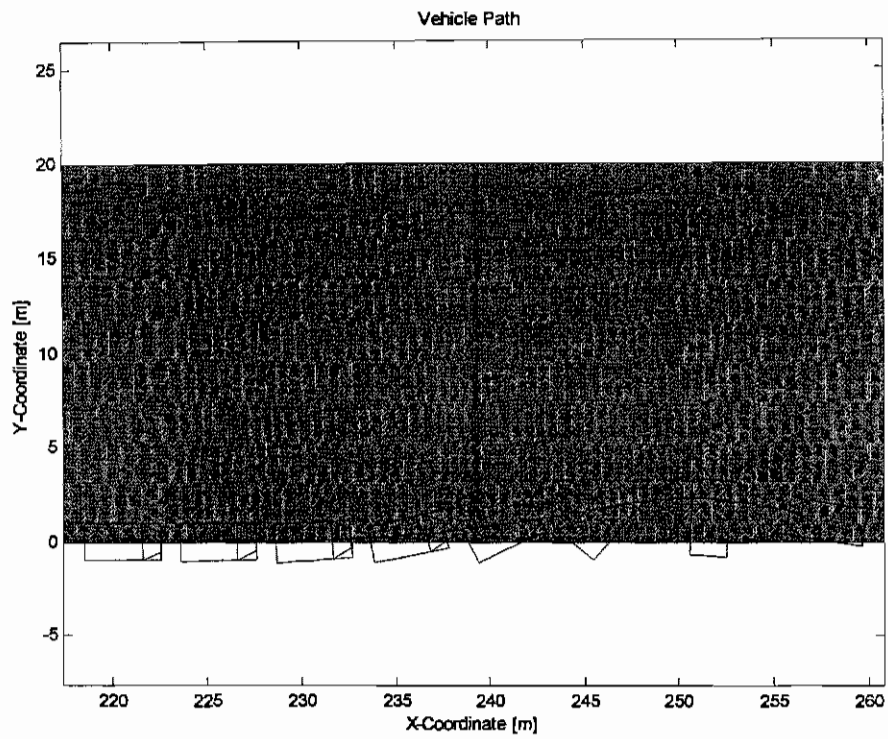

Figure 9 μ -split maneuver response